

P	LTR	DESCRIPTION	DATE	DWN	APVD
A		REVISED PER ECR-10-006194	22MAR2010	SYJ	LSF

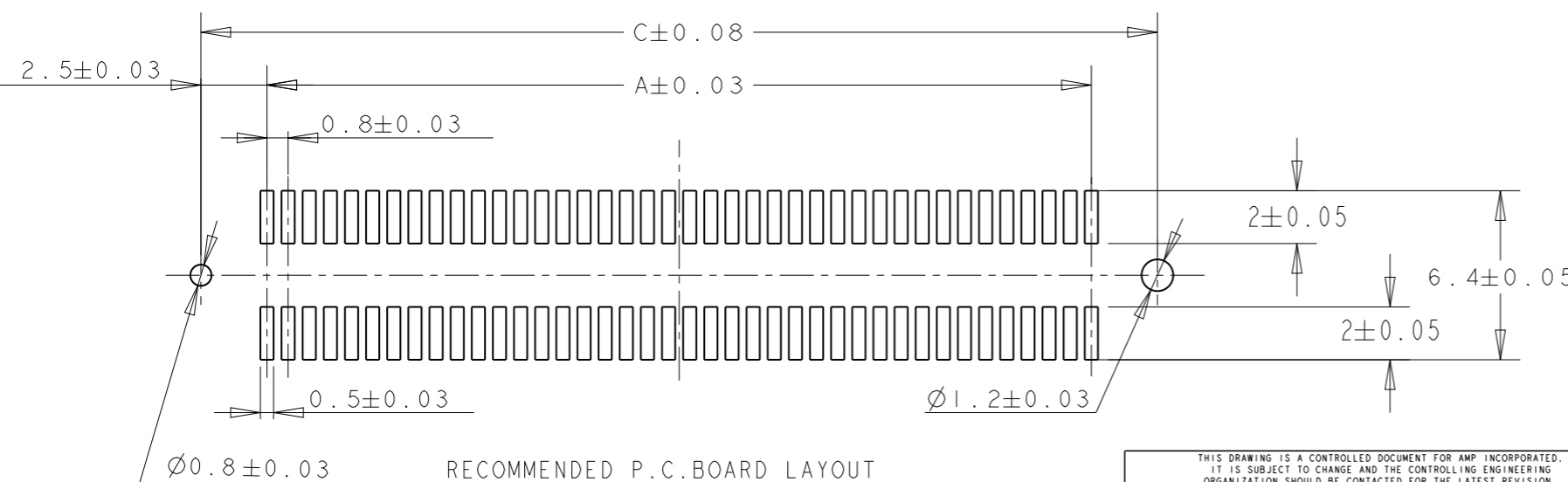
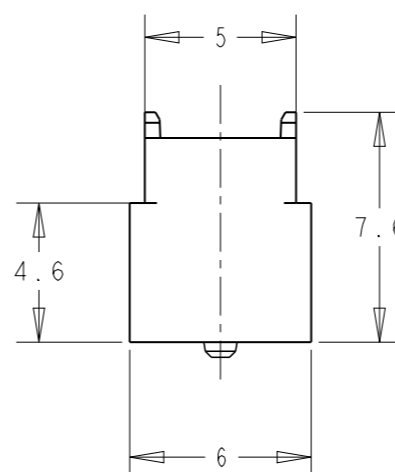
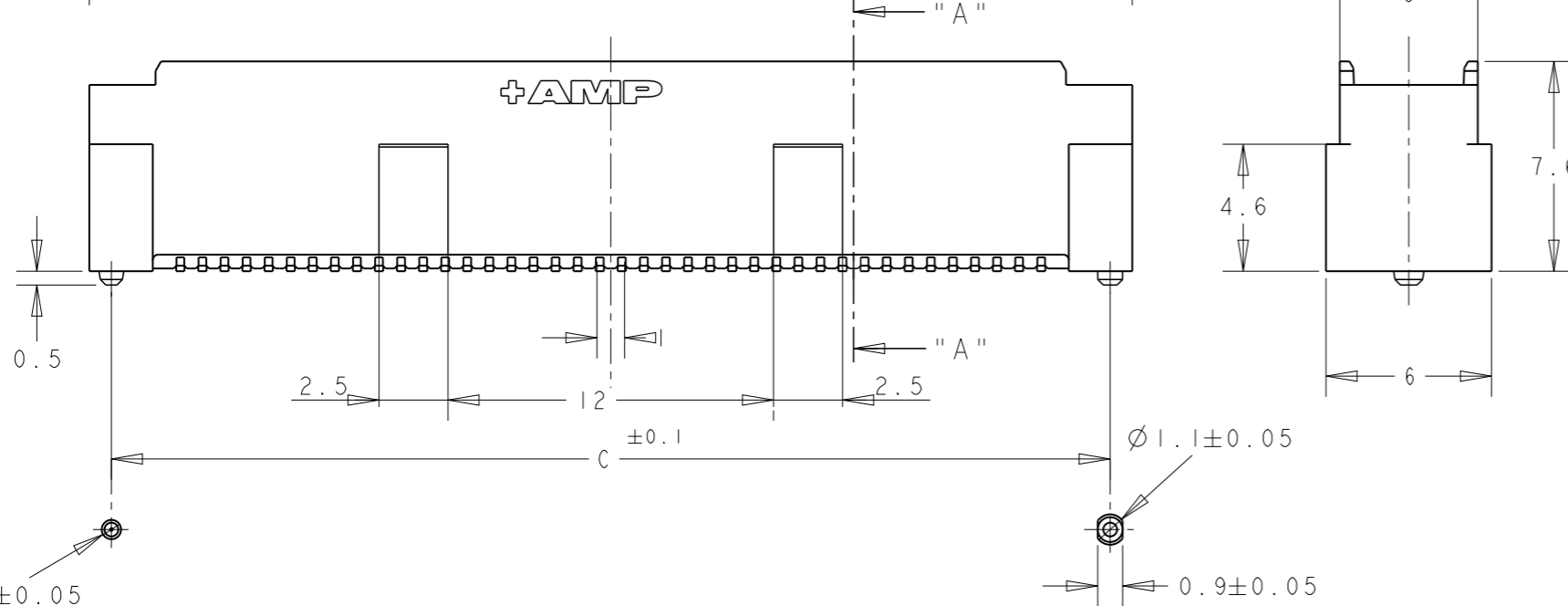
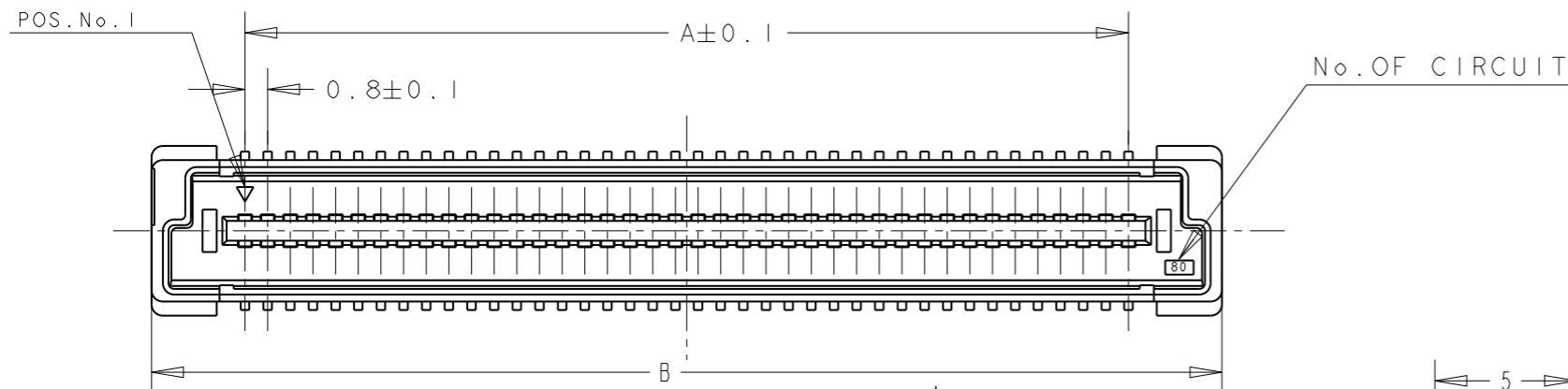

NOTES:

- 1 MATERIAL:  
HOUSING: L.C.P. (HIGH TEMP. THERMOPLASTIC)  
UL 94V-0, NATURAL.  
CONTACT: BRASS.
- 2 FINISH:  
CONTACT AREA: 0.00076 MIN GOLD ON  
0.0013 MIN ALL OVER NICKEL.  
SOLDERING AREA: 0.002 MIN MATTE-TIN.
- 3. POSITION SERIES: SEE TABLE.
- 4. CONN STACK HEIGHT COMBINE OF PLUG "Y" H VS REC "X" H.  
STACK HEIGHT = Y + X - 5

P/N SEE SHEET 2 OF 2

THIS DRAWING IS A CONTROLLED DOCUMENT FOR AMP INCORPORATED. IT IS SUBJECT TO CHANGE AND THE CONTROLLING ENGINEERING ORGANIZATION SHOULD BE CONTACTED FOR THE LATEST REVISION.

DIMENSIONS: mm	TOLERANCES UNLESS OTHERWISE SPECIFIED: 0 PLC ± 1 PLC ±0.30 2 PLC ±0.25 3 PLC ±0.20 4 PLC ± ANGLES ±3°
MATERIAL	FINISH

DWN FLORENCE TAN	14SEP04
CHK ERIC TNG	
APVD SEIFONG	
PRODUCT SPEC	108-5390
APPLICATION SPEC	114-5254
WEIGHT	-
CUSTOMER DRAWING	

Tyco Electronics Singapore

NAME  
PLUG ASSY  
FOR FH 0.8 BTB CONNECTOR 8H  
0.5 BOSS LENGTH (0.76um GOLD)

SIZE A3	CAGE CODE 00779	DRAWING NO 6123002
------------	--------------------	-----------------------

SCALE 4:1	SHEET 1 OF 2	REV A
--------------	-----------------	----------

THIS DRAWING IS UNPUBLISHED. RELEASED FOR PUBLICATION .19 .  
 © COPYRIGHT 19 BY AMP INCORPORATED. ALL RIGHTS RESERVED.

LOC DY	DIST -	REVISIONS			
P	LTR	DESCRIPTION	DATE	DWN	APVD
	-	SEE SHT 1 OF 2	-	-	-

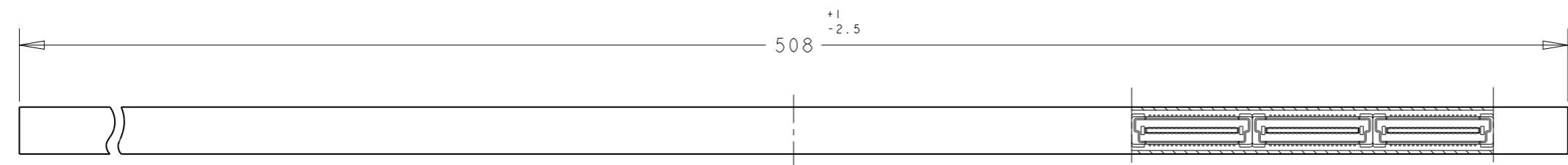

SECT A-A

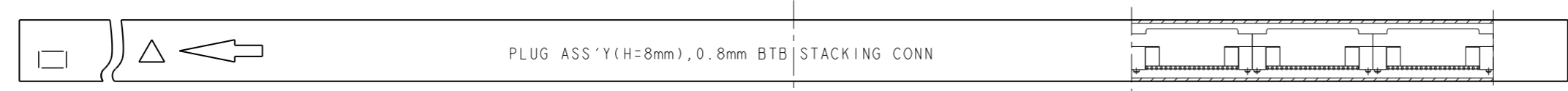

SECT B-B

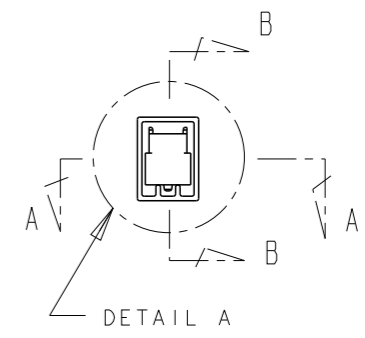

REFERENCE PICTURE OF TUBE PACK

PLUG ASS'Y (H=8mm), 0.8mm BTB STACKING CONN

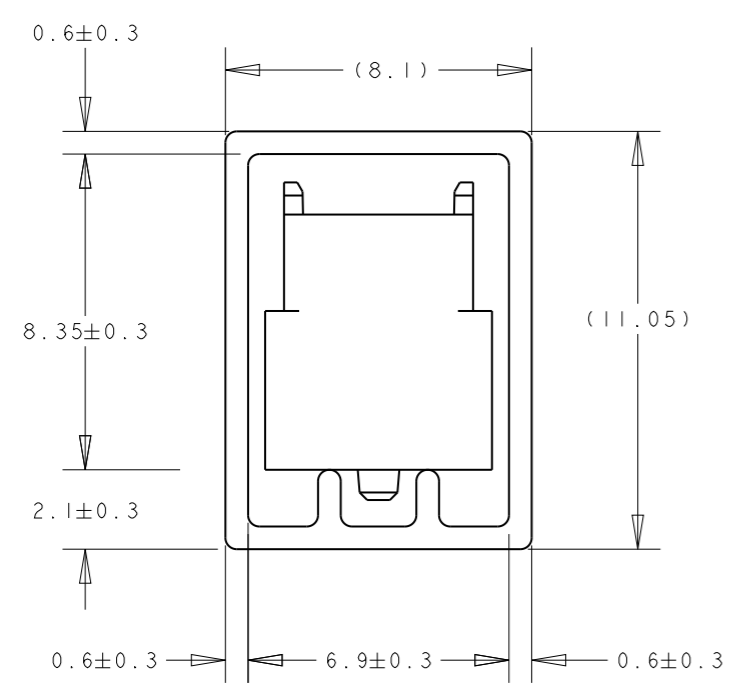

DETAIL "B"  
(SCALE 5-1)

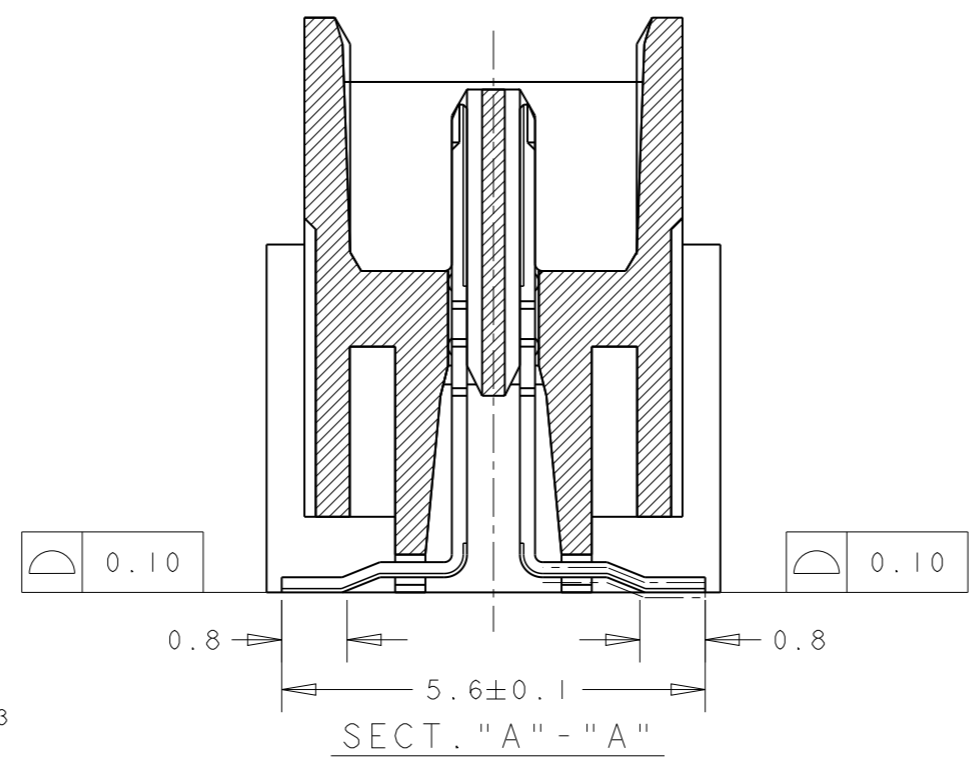

SECT. "A" - "A"

NOT AVAILABLE	14	32.2	33.8	27.2	70	1-	-1
AVAILABLE	5	84.2	85.8	79.2	200	1-	-0
	6	76.2	77.8	71.2	180		-9
	6	68.2	69.8	63.2	160		-8
	7	60.2	61.8	55.2	140		-6
	9	52.2	53.8	47.2	120		-5
	10	44.2	45.8	39.2	100		-4
	12	36.2	37.8	31.2	80		-3
	16	28.2	29.8	23.2	60		-2
	22	20.2	21.8	15.2	40		6123002-1
STATUS	QTY/TUBE	C	B	A	POS.	CONN P/N	

THIS DRAWING IS A CONTROLLED DOCUMENT FOR AMP INCORPORATED. IT IS SUBJECT TO CHANGE AND THE CONTROLLING ENGINEERING ORGANIZATION SHOULD BE CONTACTED FOR THE LATEST REVISION.

DWN 13SEP04 FLORENCE TAN  
 CHK ERIC TNG  
 APVD SEIFONG  
 PRODUCT SPEC 108-5390  
 APPLICATION SPEC 114-5254  
 WEIGHT -

**Tyco Electronics** Singapore  
 NAME PLUG ASSY FOR FH 0.8 BTB CONNECTOR 8H 0.5 BOSS LENGTH (0.76um GOLD)  
 SIZE A3 CAGE CODE 00779 DRAWING NO G-6123002

DIMENSIONS: mm TOLERANCES UNLESS OTHERWISE SPECIFIED:  
 0 PLC ±. TOLERANCES UNLESS OTHERWISE SPECIFIED:  
 1 PLC ±0.30  
 2 PLC ±0.25  
 3 PLC ±0.20  
 4 PLC ±.  
 ANGLES ±3°  
 MATERIAL FINISH

CUSTOMER DRAWING SCALE 4:1 SHEET 2 OF 2 REV A