

D-4000 Series (Wire-to-Board, Wire-to-Panel and Wire-to-Wire)

Product Facts

- 20A of current is achievable with the use of 3-position connectors
- Newly designed contacts with four contact points
- Dynamic 4000 Series achieved a 50% or greater improvement in current values compared with the Dynamic 3000 Series. At the same time, mating height increased only approximately 14%
- Current capacity per unit volume is also higher by approximately 32%
- Wire-to-board type (2-, 3- and 4-position) and wire-to-wire type (3-position). This flexible line-up will help meet customer demands. Sequential pins are also available.

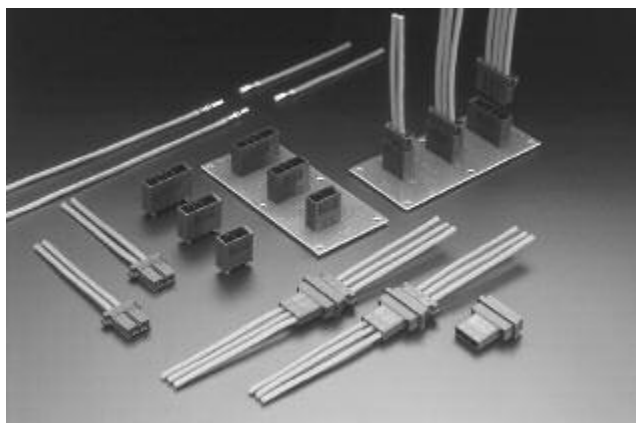

Material and Finish

Receptacle Contact — Phosphor bronze or copper alloy, gold plated with 0.38 μm nickel underplate

Tab Contact — Phosphor bronze or copper alloy, gold plated with 0.38 μm nickel underplate

Tab Post — Phosphor bronze or copper alloy, tin plated on contact area and gold plated with nickel underplate

Housing — Glass filled polyester (PBT), UL 94V-0

Performance Characteristics

Pitch — 6.35 mm (250 mils)

Voltage Rating — 600 V (rms)

Current Rating — 2-position: 24 A; 3-position: 23 A; 4-position: 22 A (when using #12 AWG wire)

Contact Resistance — 10 mΩ Max.

Dielectric Withstanding Voltage — 2,500 V (1 minute)

Operating Temperature — -55°C ~ +105°C

Technical Documents

Product Specification
108-78182

Application Specification
114-5362

D-4000 Series

D-4 Contact

0.38μm thick gold plating

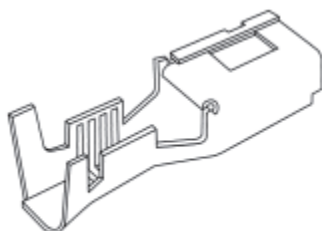

Receptacle Contact
(Used in Receptacle Housing)

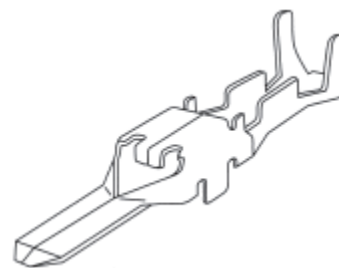

Tab Contact
(Used in Tab Housing)

Applicable Wire Range		Ins. Dia. Range mm	Wire Range Mark	Contact Part Numbers			Application Tooling	
AWG	mm ²			Receptacle	Tab	Sequential Long Tab	Mini-Applicator	Hand Tool
16	1.25	2.0~3.75	M	ST. 1747418-2	1747419-2	1-1747419-2	1762120-2	—
14	2.20			LP. 1747499-2	1747501-2	1-1747501-2	—	1762130-1
14	2.20	2.9~4.1	L	ST. 1747415-2	1747416-2	1-1747416-2	1762119-2	—
12	3.50			LP. 1747498-2	1747500-2	1-1747500-2	—	1762129-1

Notes: Minimum order quantity for tooling is one.
Extraction Tool Part Number 1762461-1 (411-78186)
Mini-Applicator is for use on Automachine.
Strip Form contacts are used with Mini-Applicator and Loose-Piece contacts are with hand tools.

D-4000 Series (Continued)

D-4200

Mating Dimensions

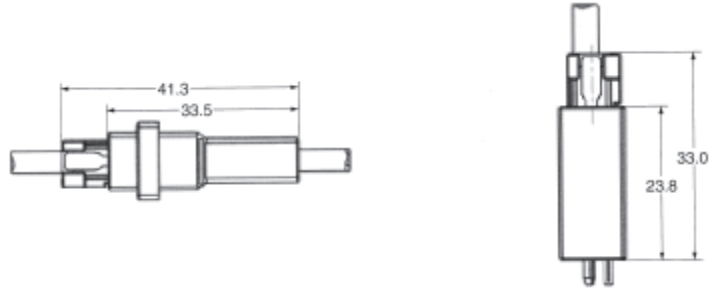

Receptacle Housing

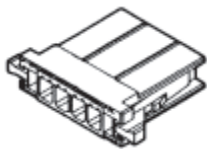

Mating Tab Housings

Part Number:

- 1747535-□
- 1747414-□
- 1747277-□

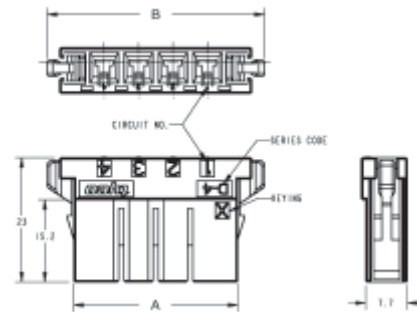

No. of Pos.	Part Number		Dimensions	
	Keying : X	Keying : Y	A	B
2	1-1747276-2	2-1747276-2	17.55	27.35
3	1-1747276-3	2-1747276-3	23.90	33.70
4	1-1747276-4	2-1747276-4	30.25	40.05

Tab Housing

Free-hanging Type

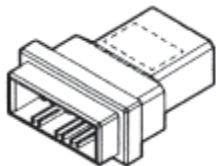

Mating Receptacle Housing

Part Number:

- 1747276-□

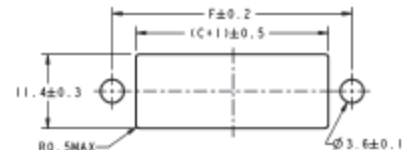

Panel Cutout

Panel Type

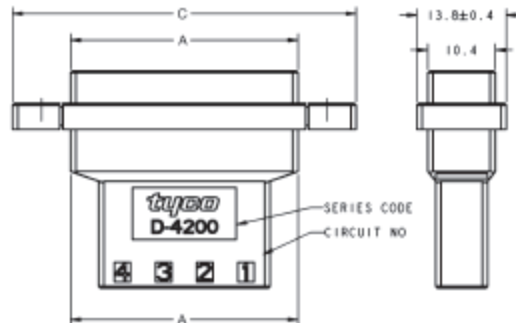
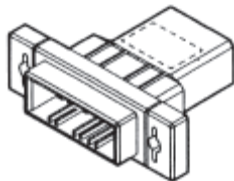

No. of Pos.	Part Number Keying : X		Part Number Keying : Y		Dimensions		
	Panel Type	Free-hanging Type	Panel Type	Free-hanging Type	A	B	C*
3	1-1747535-3	1-1747414-3	2-1747635-3	2-1747414-3	28.7	32.7	46.0

*Applicable to Panel Type only.

D-4000 Series (Continued)

D-4200 (Continued)

**Board-mounting Tab Header
(Vertical Type)**

**Mating Receptacle Housing
Part Number:
□-1747276-□**

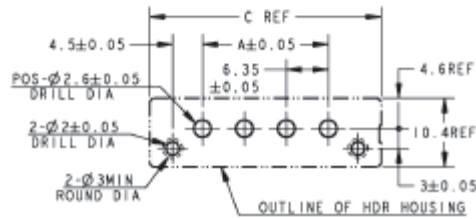
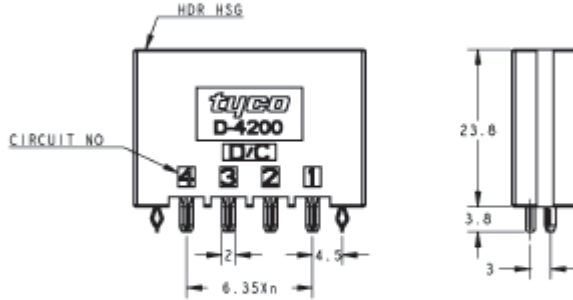
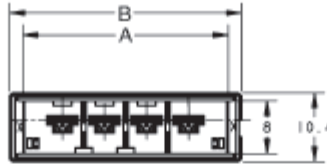
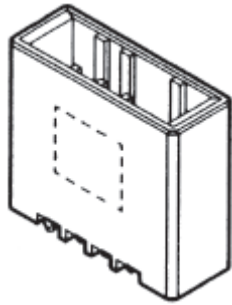

PC Board Layout
Acceptable Board Thickness:
1.6-2.4

No. of Pos.	Part Number		Dimensions	
	Keying : X	Keying : Y	A	B
2	1-1747277-2	2-1747277-2	18.35	22.35
3	1-1747277-3	2-1747277-3	24.70	28.70
4	1-1747277-4	2-1747277-4	31.05	35.05

D-4000 Series

D-5200 Series (Wire-to-Board, Wire-to-Panel and Wire-to-Wire)

D-5200S

High-Pressure
1-Row Type

List of Dynamic Series Products by Application

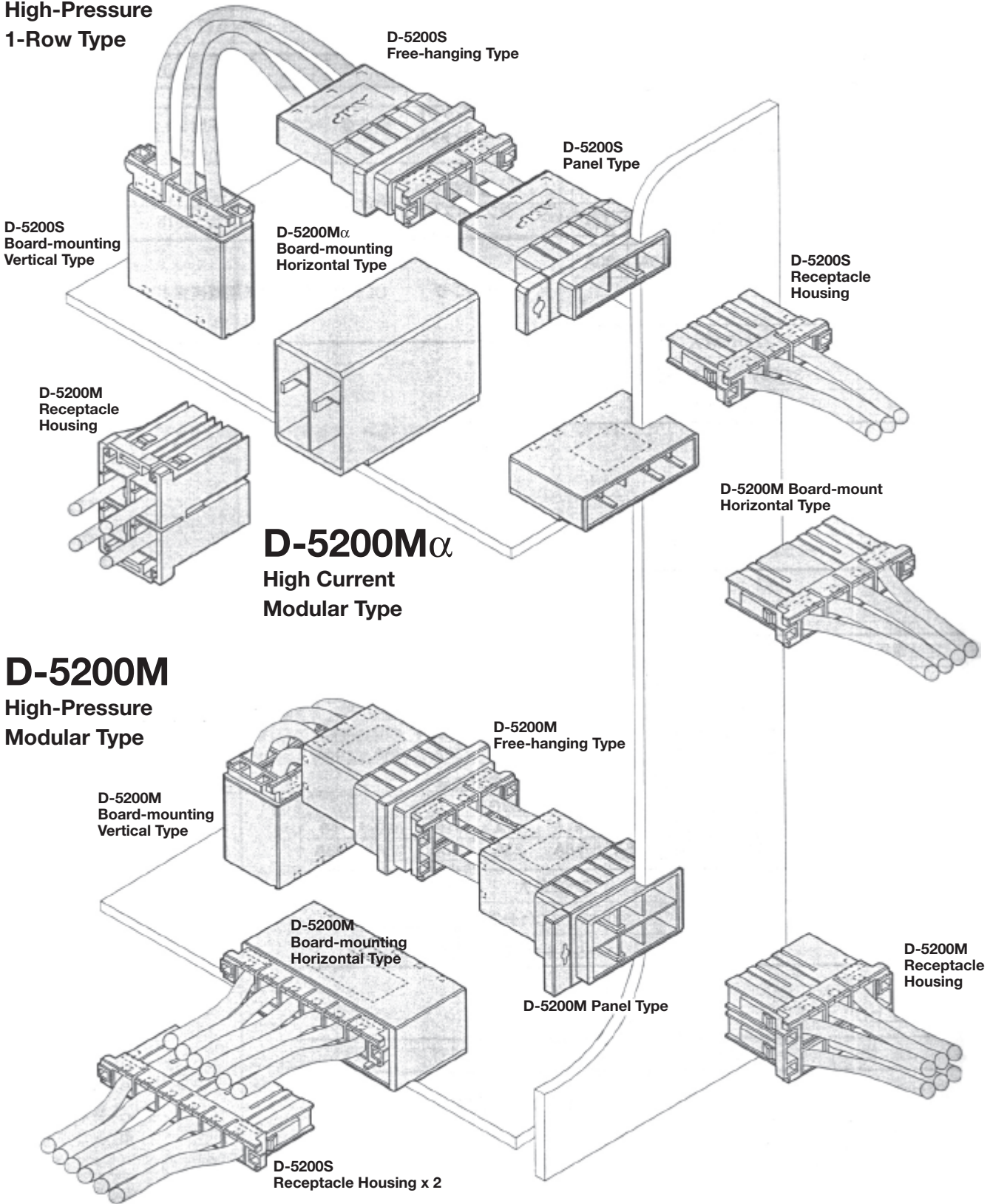

D-5200M

High-Pressure
Modular Type

D-5200 Series (Continued)

Performance Characteristics and Specifications

D-5200S/M Performance Characteristics

Pitch	400mils (10.16mm)														
Description															
Voltage Rating	630V AC														
Current Rating	<table border="1"> <thead> <tr> <th rowspan="2">Wire</th> <th colspan="4">AWG</th> </tr> <tr> <th>#16</th> <th>#14</th> <th>#12</th> <th>#10</th> </tr> </thead> <tbody> <tr> <td>Current</td> <td>16A</td> <td>19A</td> <td>25A</td> <td>30A</td> </tr> </tbody> </table> <p>6 position max.</p>	Wire	AWG				#16	#14	#12	#10	Current	16A	19A	25A	30A
Wire	AWG														
	#16	#14	#12	#10											
Current	16A	19A	25A	30A											
Contact Resistance	2mΩ Max.														
Dielectric Withstanding Voltage	3,000V AC (1 minute)														
Operating Temperature	-55°~+105°C														

Material and Finish

Description	Material	Finish
Receptacle Contact Tab Contact	Copper alloy	Gold plating with underplated nickel
Tab Post	Copper alloy	Gold plating with underplated nickel
Housing	UL 94V-0 rated, glass filled polyester (PBT)	

D-5200Mα Performance Characteristics

Pitch	400mils (10.16mm)																																														
Description																																															
Voltage Rating	630V AC																																														
Current Rating	<p>Current for 3-pos. silver-plated contacts</p> <table border="1"> <thead> <tr> <th rowspan="2">Wire</th> <th colspan="7">AWG</th> </tr> <tr> <th>#20</th> <th>#18</th> <th>#16</th> <th>#14</th> <th>#12</th> <th>#10</th> <th>#8</th> </tr> </thead> <tbody> <tr> <td>Current</td> <td>12A</td> <td>16A</td> <td>20A</td> <td>25A</td> <td>33A</td> <td>38A</td> <td>45A</td> </tr> </tbody> </table> <p>Current for 4-pos. silver-plated contacts</p> <table border="1"> <thead> <tr> <th rowspan="2">Wire</th> <th colspan="7">AWG</th> </tr> <tr> <th>#20</th> <th>#18</th> <th>#16</th> <th>#14</th> <th>#12</th> <th>#10</th> <th>#8</th> </tr> </thead> <tbody> <tr> <td>Current</td> <td>12A</td> <td>15A</td> <td>18A</td> <td>23A</td> <td>31A</td> <td>35A</td> <td>43A</td> </tr> </tbody> </table>	Wire	AWG							#20	#18	#16	#14	#12	#10	#8	Current	12A	16A	20A	25A	33A	38A	45A	Wire	AWG							#20	#18	#16	#14	#12	#10	#8	Current	12A	15A	18A	23A	31A	35A	43A
Wire	AWG																																														
	#20	#18	#16	#14	#12	#10	#8																																								
Current	12A	16A	20A	25A	33A	38A	45A																																								
Wire	AWG																																														
	#20	#18	#16	#14	#12	#10	#8																																								
Current	12A	15A	18A	23A	31A	35A	43A																																								
Contact Resistance	2mΩ Max.																																														
Dielectric Withstanding Voltage	3,000V AC (1 minute)																																														
Operating Temperature	-55°~+105°C																																														

Material and Finish

Description	Material	Finish
Receptacle Contact Tab Contact	Copper alloy	Silver plating with underplated nickel
Tab Post	Copper alloy	Silver plating with underplated nickel
Housing	UL 94V-0 rated, glass filled polyester (PBT)	

D-5000 Series

D-5200 Series (Continued)

Performance Characteristics and Specifications (Continued)

Technical Documents Specifications and Instruction Sheets

Product Specification		108-5453
Test Report		501-5188
Application Specification		114-5206
Hand Tool Instruction Sheets	Crimping Tool P/N : 234170-1	411-5712
	Crimping Tool P/N : 234171-1	411-5713
	Crimping Tool P/N: 1366656-1	411-5969
	Crimping Tool P/N: 1366044-1	411-5976
Extraction Tool (Part Number 409158-1) Instruction Sheet		411-5774

*Don't fail to obtain Instruction Sheets and other appropriate papers when you adopt our products.

Safety Specifications

The following safety specifications are applicable to specific Part Numbers. Contact Technical Support to check if approval is given for each Part Number you are using. Note that there are instances where values differ from those given in Tyco Electronics Performance Data.

	D-5200 Series (400 mil, 10.16mm pitch)			D-5200Mα Series			
	Voltage Rating	Current Rating	Temperature Rating	Voltage Rating	Current Rating	Temperature Rating	
Specification 108-5453	630V AC	See preceding page	-55°~+105°C	—	See preceding page	-55°~+105°C	
UL File No. E28476 (Recognized Component)	Determined by requirements of equipment in use.	Determined by requirements of equipment in use.	—	—	Determined by requirements of equipment in use.	—	
CSA Report No. LR7189	600V AC	AWG A	—	—	—	—	
		16 13					
		14 18					
		12 25					
		10 30					
TÜV License No. R9650368 IP Protection IP-10 Overvoltage Classification (II) Number of repeated insertions and withdrawals allowed: 50 times.	600V AC	AWG A	-30°~+105°C	—	Pos.		-30°~+105°C
		16 15			1~3 4		
		14 20			20 12.5 12.5		
		12 25			18 17.5 16		
		10 30			16 21 19.5		
					14 26 24		
					12 33 31		
					10 40 37.5		
		8 48 46					

D-5200 Series (Continued)

Crimp Type Contacts

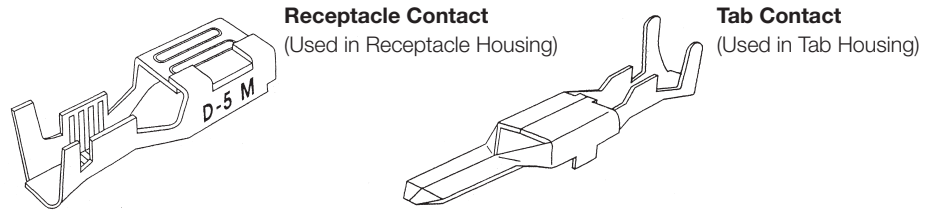

D-5 Contacts

Wire Range		Ins. Dia. Range mm	Wire Range Mark	Contact Part Numbers*			Application Tooling		
AWG	mm ²			Receptacle	Tab	Sequential Tab	Mini-Applicator	Hand Tool	
16	1.25	3~3.8	S	ST.	179955-□	917802-□	84696-1	**	—
14	2.20			LP.	316040-□	917804-□	—	—	234170-1
12	3.50	4~5.2	M	ST.	179956-□	917803-□	84695-1	**	—
10	5.50			LP.	316041-□	917805-□	—	—	234171-1

Note: Enter the following plating code in Part Number suffix-□:
 -2 = 0.38 μm thick gold plating, -3 = 0.76μm thick gold plating,
 -6 = 2.54 μm thick silver plating

* Strip Form contacts are used with Mini-Applicator and Loose-Piece contacts are with hand tools.

**Mini-Applicator is for use on Automachines. (See next page. Contact Technical Support for details.)

D-5α Contacts (Silver Plating)

Wire Range		Ins. Dia. Range mm	Wire Range Mark	Contact Part Numbers*		Application Tooling	
AWG	mm ²			Receptacle	Mini-Applicator	Hand Tool	
20	0.50	1.8~3.23	SS	ST.	1318985-6	**	—
16	1.25			LP.	1318986-6	—	91596-1
16	1.25	3~3.80	S	ST.	179955-6	**	—
14	2.20			LP.	316040-6	—	234170-1
12	3.50	4~5.2	M	ST.	179956-6	**	—
10	5.50			LP.	316041-6	—	234171-1
8	8.00	4.9~7.8	L	ST.	1318696-6	**	—
				LP.	1318697-6	—	1366044-1

Note: The contact part numbers with "-6" are silver plated with 2.54 μm thickness.

* Strip Form contacts are used with Mini-Applicator and Loose-Piece contacts are with hand tools.

**Mini-Applicator is for use on Automachines. (See next page. Contact Technical Support for details.)

Application Tooling

Extraction Tool
Part Number: 409158-1

Instruction Sheet 411-5774

- Used to extract contacts from wire type tab / receptacle housing.
 (Take care when inserting tool as the lance section of D-5 is turned upside down to that of D-3.)
- With D-5 contacts only, it is possible to extract using a small-size slotted screwdriver.

• How to Use Extraction Tool

-
- Insert Extraction Tool in the direction as shown, insert into the narrow lower section of Housing's reverse convex hole. (make sure that you are holding tool in proper position, top and bottom.)
- * Take care not to insert tool into contact section. If you've inserted by error, replace the contact with a new one before proceeding.

When Using D-5 Extraction Tool

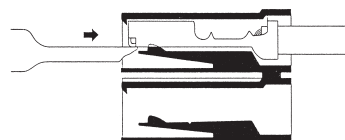

② The tip of Extraction Tool depresses housing lance, freeing contact.

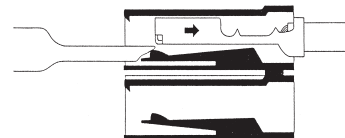

③ Contact can now be pulled out.

When Using Slotted Screwdriver

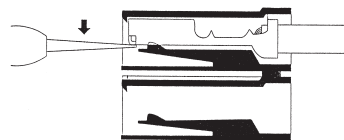

② When you butt the tip of tool at lance section and depress it, contact is released.

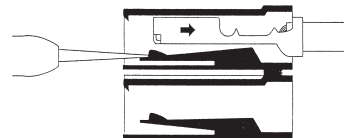

③ Contact can be pulled out.

D-5200 Series (Continued)

Application Tooling

(Continued)

AMP-3K/40 and AMP-5K/40 Terminating Machines

The AMP-3K/40 and AMP-5K/40 Terminators are designed for customers that require the increased output and quality of a semi-automatic machine at a competitive price. By incorporating the most commonly requested features as standard and offering a long list of optional equipment, these terminators offer flexibility to meet the specific needs of various applications at the lowest possible cost.

- 3,000 lb. [1361 kg] max. crimp force (AMP-3K/40)
- 5,000 lb. [2268 kg] max. crimp force (AMP-5K/40)
- Toolless removal of applicators and guards
- Jog capability
- Quiet, fast operation — 80/76 dBA and cycle time less than 0.400 seconds
- Accepts Heavy Duty Mini style applicators
- Wide range of optional equipment such as toolless precision crimp height adjust, batch counter, CQM capability and work light
- Order Catalog 1654856 for specifications and part numbers

Hand Tool

The crimping section incorporates Straight Action construction for improved reliability as with automachine.

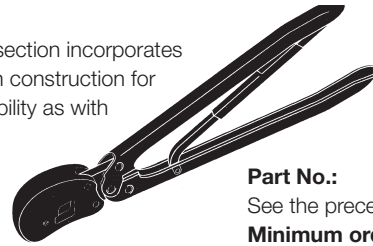

Part No.:

See the preceding page.

Minimum order quantity: 1

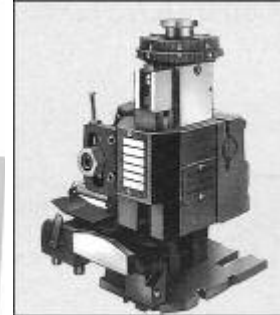

Mini-Applicator

Part Number: Contact Technical Support

Minimum order quantity: 1

AMP-O-LECTRIC Model G Terminating Machine

The Model "G" Terminator is the most advanced design in the long-standing series of AMP-O-LECTRIC machines for terminating wire using reeled terminals and contacts. It features a reliable direct motor drive system. Its modular construction enables it to be used either as a bench-top unit, or in combination with fully-automatic lead-making equipment. For operator convenience, access to and lighting in the target area has been improved and the Crimp Quality Monitor (CQM) has been moved to eye level for bench-top use. The Model "G" is also quieter, plus improved guarding meets applicable European and domestic safety requirements.

- Quieter
- Improved guarding and lighting
- Toolless changeover of applicators
- Precision manual- or auto-adjust for crimp height
- Total and batch counter
- Accepts all existing Tyco Electronics miniature applicators, with minor modifications
- Reduced maintenance requirements
- Request Catalog 65828 for specifications and part numbers



Mini-Applicator

Part Number: Contact Technical Support.

Minimum order quantity: 1

Mounting Hardware

Attachment

Sequential Clip

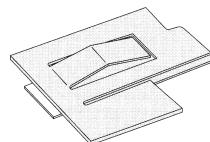

Part Number: 179993-1

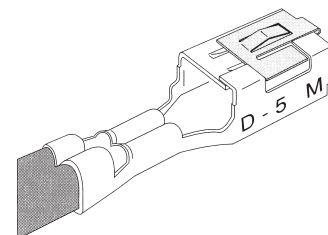

D-5200 Series (Continued)

D-5200S — Standard 1-Row Type

Appearance Board mounting pitch: 400mils (10.16mm)
Dielectric Withstanding Voltage: 3,000V (for one minute)
Voltage Rating: 630V AC

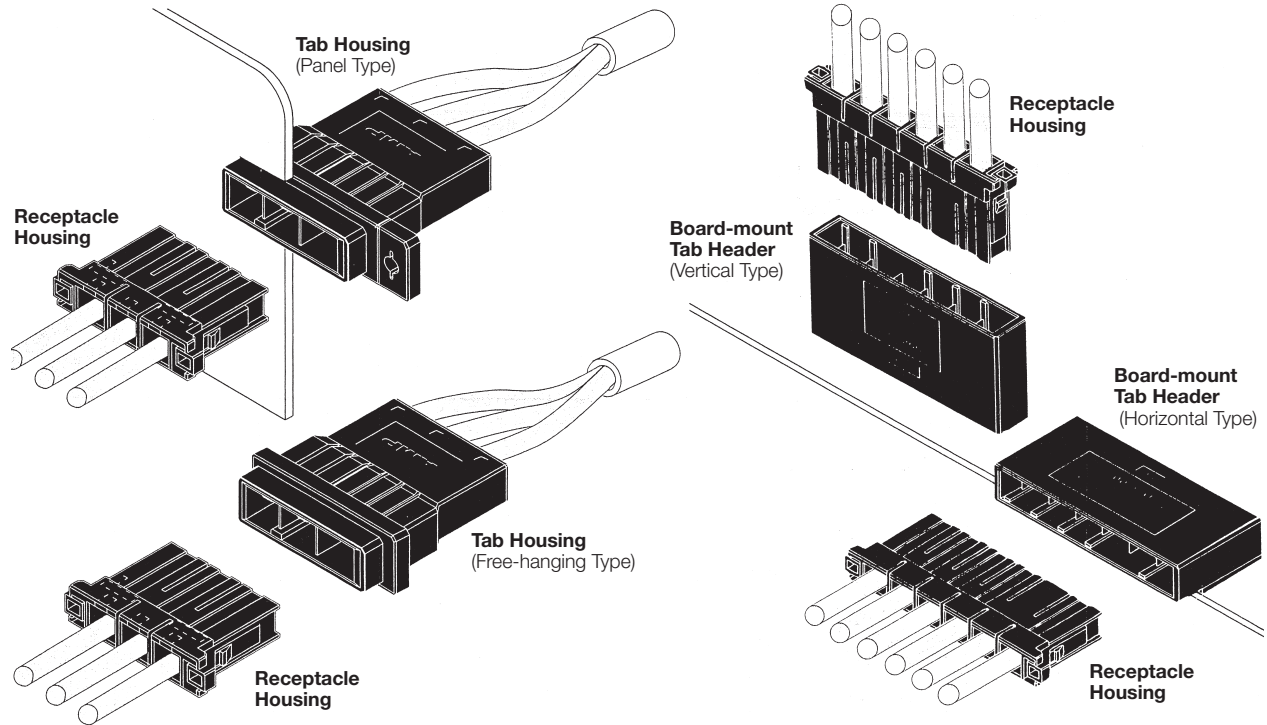

D-5000 Series

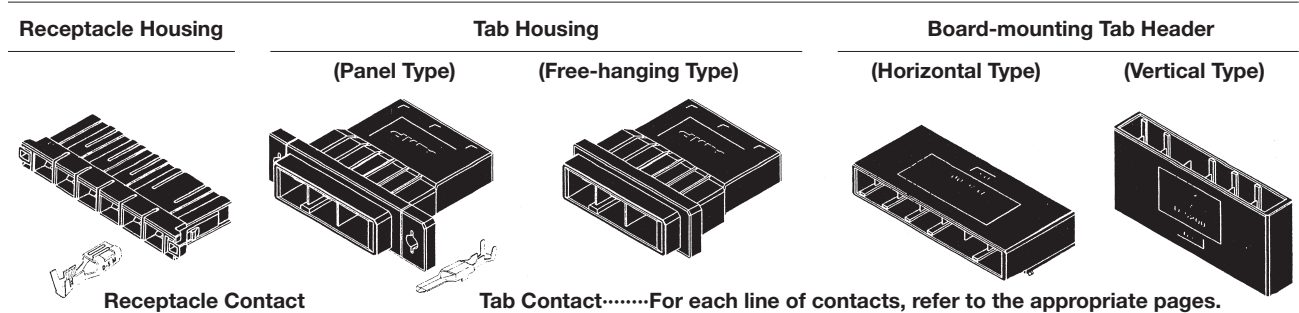

Receptacle Contact

Tab Contact.....For each line of contacts, refer to the appropriate pages.

No. of Pos.	Keying	Part Number of Receptacle Housings	Part Number of Tab Housings		Part Number Board-mounting Tab Headers				
			Panel Type	Free-hanging Type	Horizontal Type	Sequential Type	Vertical Type	Sequential Type	
2	X	1-179958-2	1-353047-2	1-353046-2	1-353079-□	—	1-353080-□	—	
	Y	2-179958-2	2-353047-2	2-353046-2	2-353079-□	—	2-353080-□	—	
3	X	1-179958-3	1-353047-3	1-353046-3	1-353081-□	8-350381-2	1-353082-□	8-353082-2	
	Y	2-179958-3	2-353047-3	2-353046-3	2-353081-□	9-350381-2	2-353082-□	9-353082-2	
4	X	1-179958-4	Use low 4- and 6-position D-5200MS, 4- and 6-position Panel and Free-hanging Types.		1-917541-□	8-917541-2	1-917542-□	8-917542-2	
	Y	2-179958-4			2-917541-□	9-917541-2	2-917542-□	9-917542-2	
5	X	—			—	—	—	—	—
	Y	—			—	—	—	—	—
6	X	1-179958-6			1-179959-□	—	1-179960-□	—	—
	Y	2-179958-6			2-179959-□	—	2-179960-□	—	—

Note: Enter the following plating code in Part Number suffix-□
-2 = 0.38 μm thick gold plating
-3 = 0.76 μm thick gold plating

D-5200 Series (Continued)

D-5200S — Standard
1-Row Type (Continued)

Keying

Keying is provided with this product (D-5200S) to help prevent misinsertion. Two types, X and Y, are available. (Shown below is the mated interface of Tab Header.)



Application

Servomotor / servodriver—Typical Application

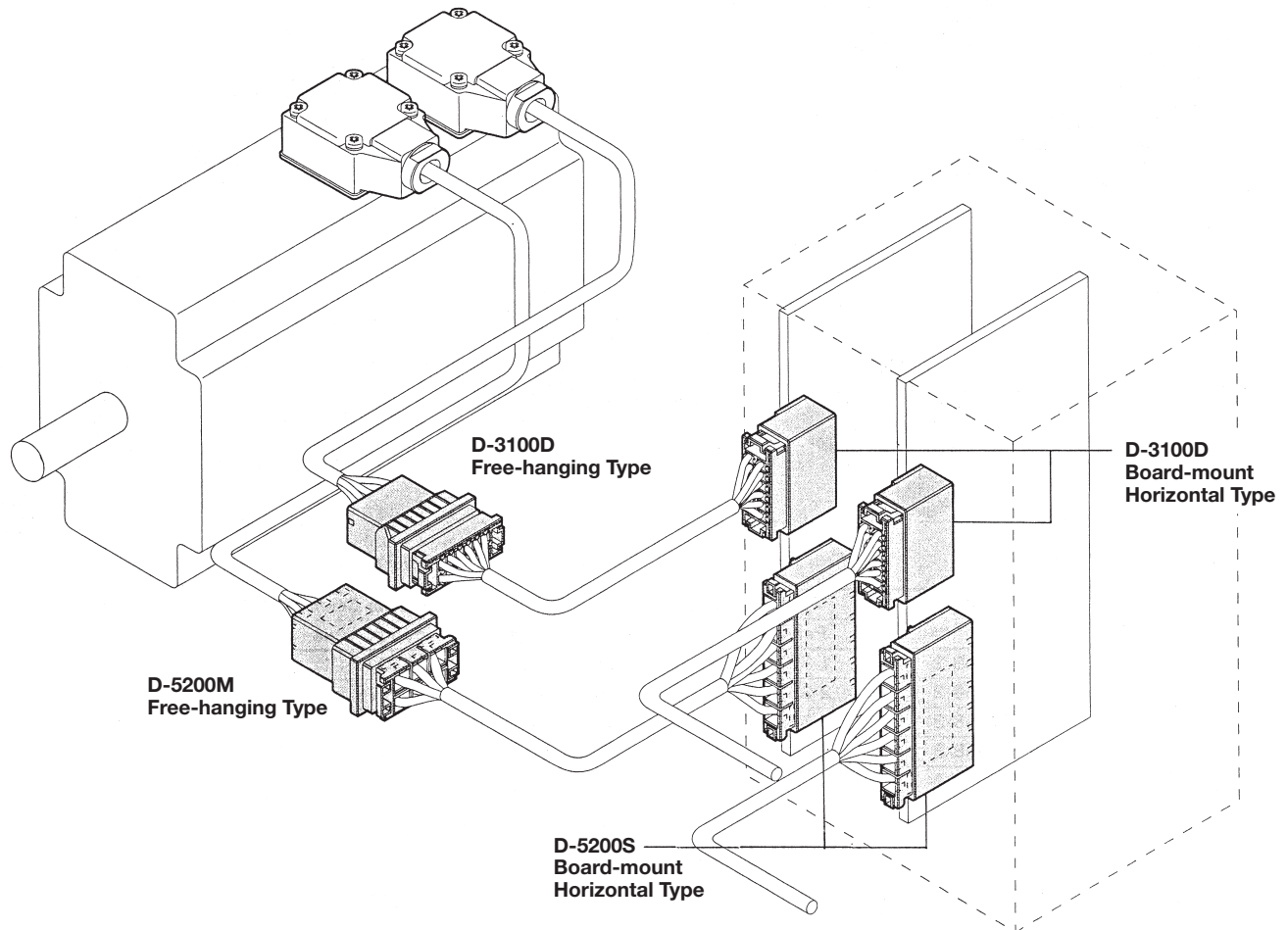

D-5000 Series

D-5200 Series (Continued)

D-5200S — Standard
1-Row Type (Continued)

Mating Dimensions

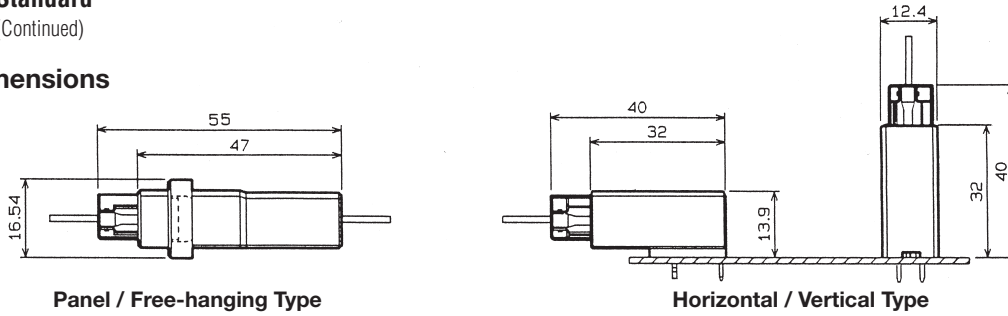

External Dimensions
Receptacle Housing

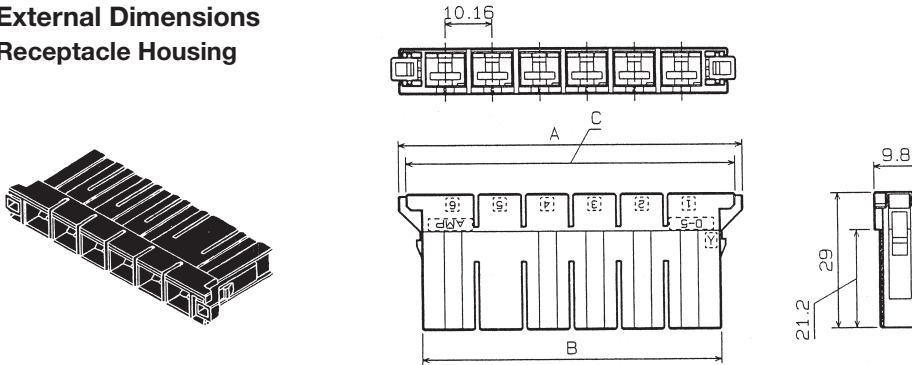

Mating Tab Connector
Part Number:

- 353047-□
- 353046-□
- 353079-□
- 353081-□
- 917541-□
- 179959-□
- 353080-□
- 353082-□
- 917542-□
- 179960-□

No. of Positions	Part Number of Receptacle Housing	Dimensions	
		A	B
2	□-179958-2	35.76	23.76
3	□-179958-3	45.92	33.92
4	□-179958-4	53.68	44.08
5	—	—	—
6	□-179958-6	74.00	64.40

Tab Housing

Panel Type

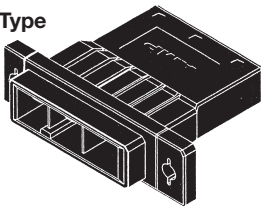

Mating Receptacle Housing
Part Number:
□-179958-□

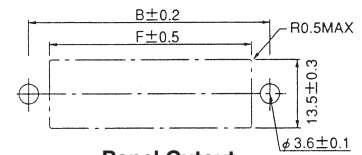
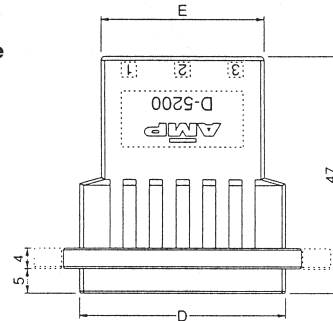

Panel Cutout

When mounting panel from the front, apply clamping torque of less than 49N [11 lbf].

Free-hanging Type

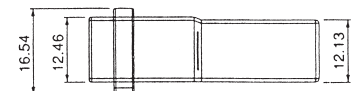
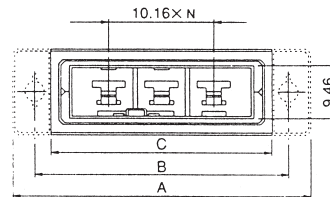
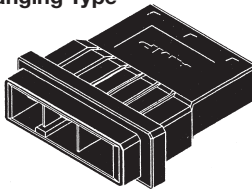

No. of Pos.	Part Number of Tab Housing		Dimensions					
	Panel Type	Free-hanging Type	A	B	C	D	E	F
2	□-353047-2	□-353046-2	47	38	33.44	29.36	21.11	30.4
3	□-353047-3	□-353046-3	57	48	43.6	39.52	31.27	40.5

D-5200 Series (Continued)

D-5200S — Standard 1-Row Type (Continued)

Board-mount Tab Header (Horizontal Type)

Mating Receptacle Housing
Part Number:

□-179958-□

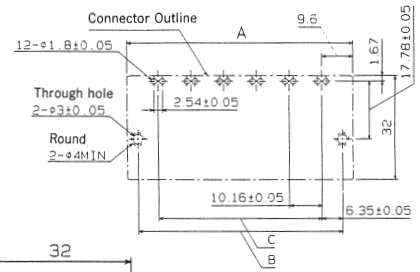
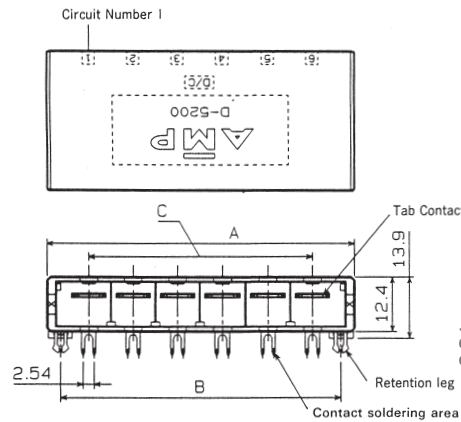
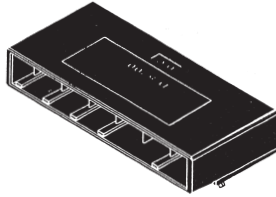

PC Board Layout
Applicable Board Thickness: 1.6-2.4±0.1

No. of Pos.	Part Number of Tab Header	Dimensions		
		A	B	C
2	□-353079-□	29.36	22.86	10.16
3	□-353081-□	39.52	33.02	20.32
4	□-917541-□	49.68	43.18	30.48
5	—	—	—	—
6	□-179959-□	70.00	63.50	50.80

Tube Package Dimensions (Ref.)

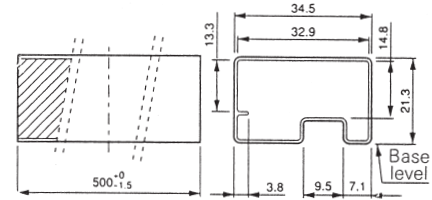

Board-mount Tab Header (Vertical Type)

Mating Receptacle Housing
Part Number:

□-179958-□

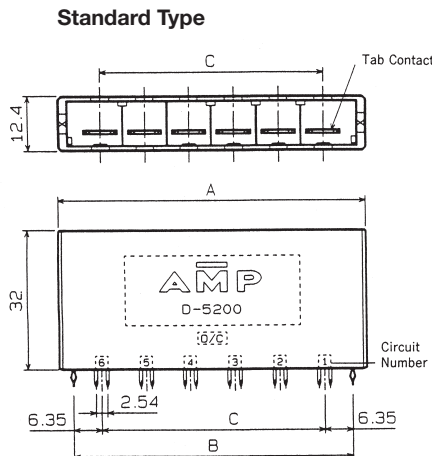
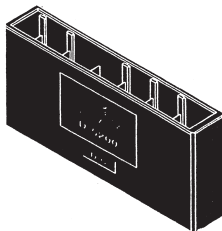

PC Board Layout
Applicable Board Thickness: 1.6-2.4±0.1

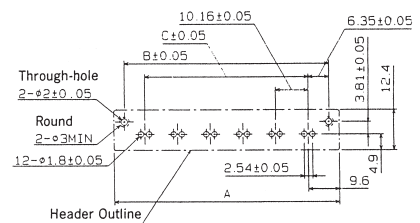

Sequential Type

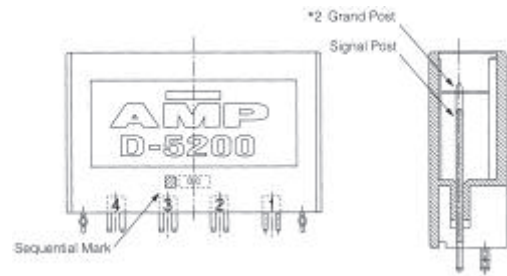

No. of Pos.	Part Number		Dimensions		
	Standard Type	Sequential Type	A	B	C
2	□-353080-□	—	29.36	22.86	10.16
3	□-353082-□	□-353082-2*1	39.52	33.02	20.32
4	□-917542-□	□-917542-2*1	49.68	43.18	30.48
5	—	—	—	—	—
6	□-179960-□	—	70.00	63.50	50.80

Tube Package Dimensions (Ref.)

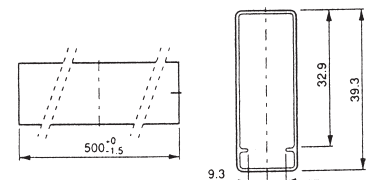

*1 In the of the sequential type, enter 8- for X type, and enter 9- for Y type.
*2 For the 3 pos. connector assembly, the sequential post is inserted in the circuit No. 3.
For the 4 pos. connector assembly, the sequential post is inserted in the circuit No. 4.

D-5200 Series (Continued)

D-5200M — Modular Type

D-5200M—Can be used for modular application in conjunction with D-5200S. Also used for power distribution.

Board mounting pitch: 400x400mils (10.16x10.16mm)
Dielectric Withstanding Voltage: 3,000V (for one minute)
Voltage Rating: 630V AC (when one connector is used)

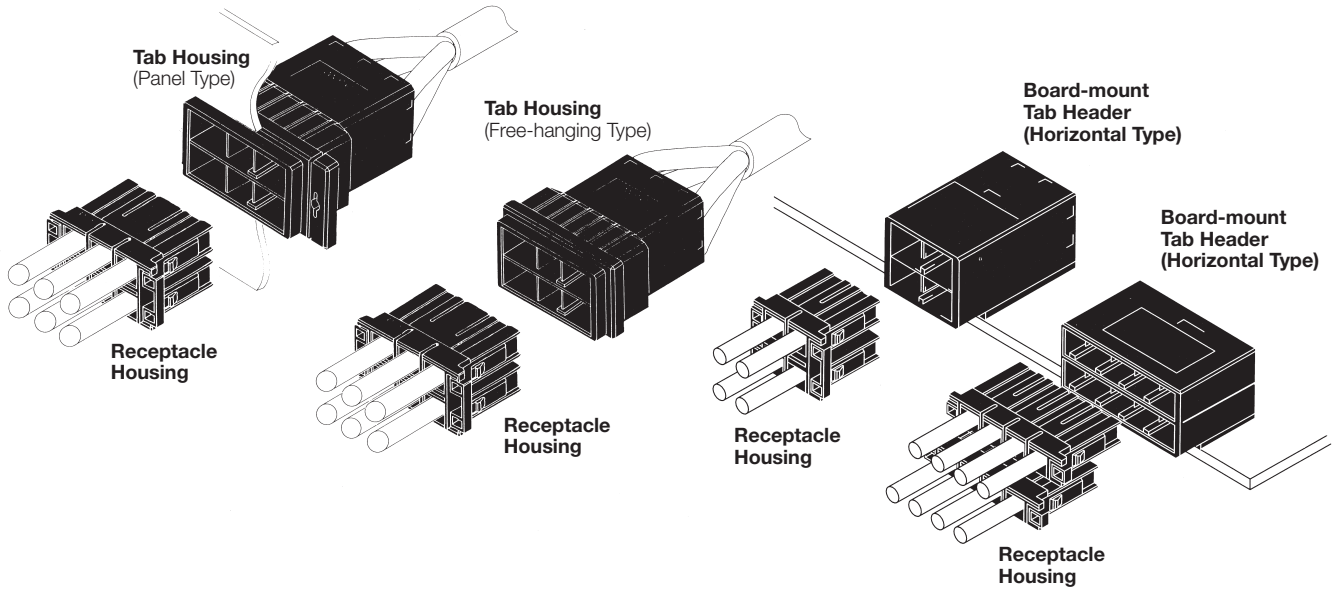

D-5000 Series

Receptacle Housing

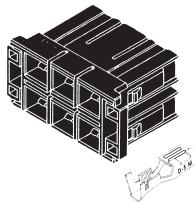

Receptacle Contact

Tab Housing

(Panel Type)

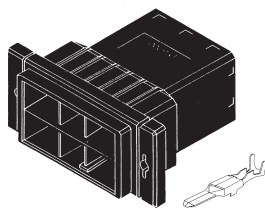

(Free-hanging Type)

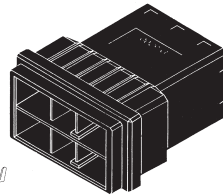

Tab Contact.....For each line of contacts, refer to the appropriate page.

Board-mounting Tab Header

(Horizontal Type)

4 Pos.

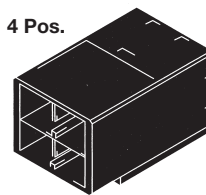

8 Pos.

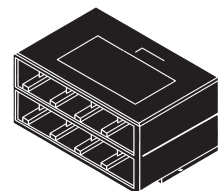

No. of Pos.	Keying	Part Number of Receptacle Housings	Part Number of Tab Housing		Board-mounting Tab Header	
			Panel Type	Free-hanging Type	Horizontal Type	Sequential Type
4	XX	1-917807-2	1-917809-2	1-917808-2	1-1123309-□	8-1123309-2
	YY	2-917807-2	2-917809-2	2-917808-2	2-1123309-□	9-1123309-2
	XY	3-917807-2	3-917809-2	3-917808-2	3-1123309-□	5-1123309-2
6	XX	1-917807-3	1-917809-3	1-917808-3	—	—
	YY	2-917807-3	2-917809-3	2-917808-3	—	—
	XY	3-917807-3	3-917809-3	3-917808-3	—	—
8	XX	—	—	—	1123829-1*	—

Note: Enter the following plating code in Part Number suffix-□ :
-2 = 0.38 μm thick gold plating
-3 = 0.76 μm thick gold plating

*This connector is made by 2 pieces of 4 pos. connectors.

D-5200 Series (Continued)

D-5200M — Modular Type

(Continued)

Keying

Keying is provided with this product (D-5200M) to help prevent misinsertion. Three types, XX, YY, and XY, are available. (Shown below is the mated interface of Tab Header.)

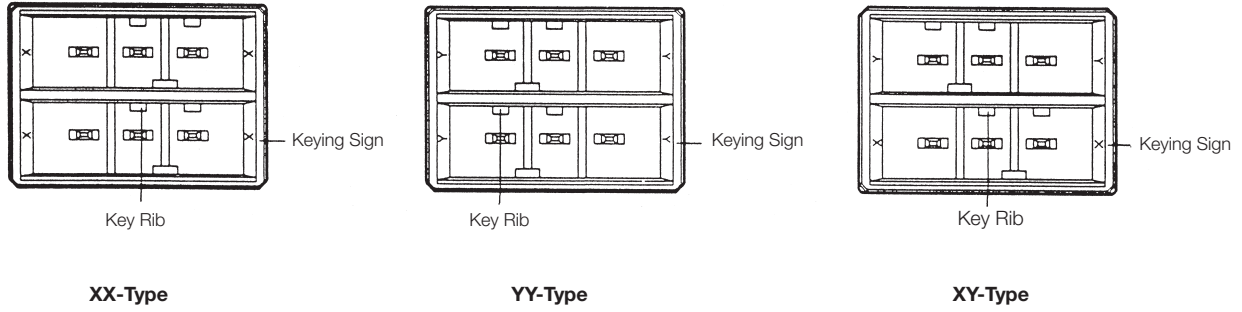

Table of Mating Combinations

Receptacle Housing		Tab Housing		Board-mount Tab Header	
1 Row (D-5200S) *	X-Type		1 Row (D-5200S) Panel Type 	1 Row (D-5200S) Horizontal Type 	X-Type Horizontal Type
	Y-Type		Free-hanging Type 	Vertical Type 	Y-Type Horizontal Type Vertical Type
2 Row	XX-Type		2 Rows Panel Type 	2 Rows Horizontal Type 	XX-Type Horizontal Type Vertical Type
	YY-Type		Free-hanging Type 	Vertical Type 	YY-Type Horizontal Type Vertical Type
	XY-Type		Free-hanging Type 	Vertical Type 	XY-Type Horizontal Type Vertical Type

*D-5200S Series

D-5200 Series (Continued)

D-5200M — Modular Type

(Continued)

Mating Dimensions

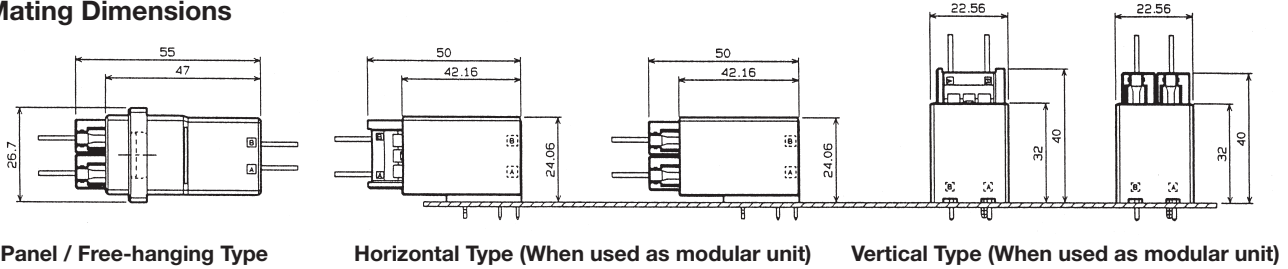

Receptacle Housing

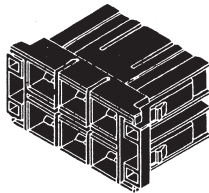

Mating Tab Connector Part Number:

- 917809-□
- 917808-□
- 1123829-1
- 1123309-□

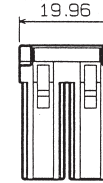
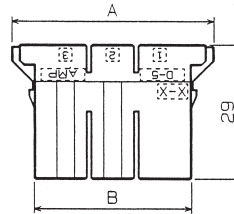
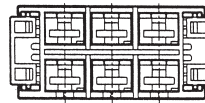

No. of Positions	Part Number of Receptacle Housing	Dimensions	
		A	B
4	□-917807-2	33.36	23.76
6	□-917807-3	43.52	33.92

Tab Housing

Panel Type

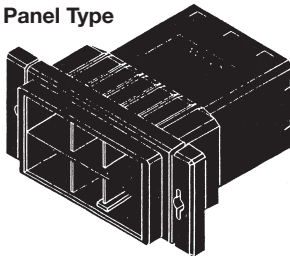

Mating Receptacle Housing Part Number:
□-917807-□

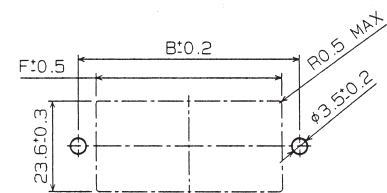
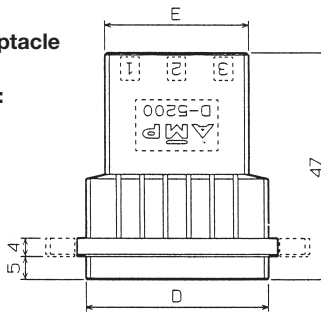

Panel Cutout

When mounting panel from the front, apply clamping torque of less than 49N [11 lbf].

Free-hanging Type

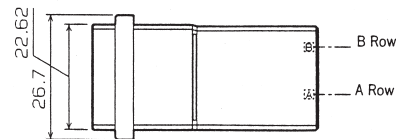
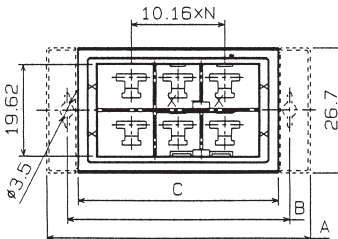
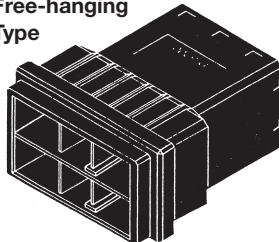

No. of Pos.	Part Number of Tab Housing		Dimensions					
	Panel Type	Free-hanging Type	A	B	C	D	E	F
4	□-917809-2	□-917808-2	47	38	33.44	29.36	21.11	30.40
6	□-917809-3	□-917808-3	57	48	43.60	39.52	31.27	40.50

D-5000 Series

D-5200 Series (Continued)

D-5200M — Modular Type

(Continued)

Board-mount Tab Header (Horizontal Type)

Mating Receptacle Housing
Part Number:
 □-917807-□

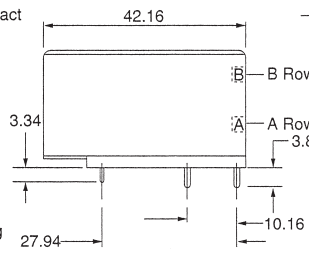
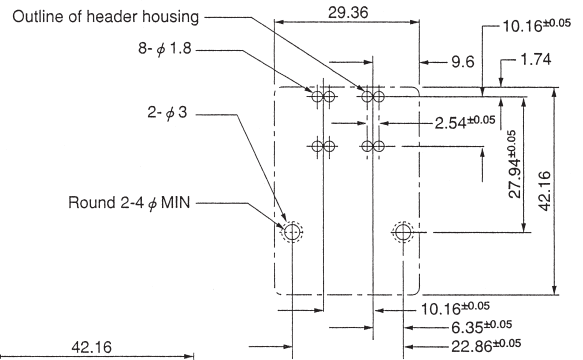
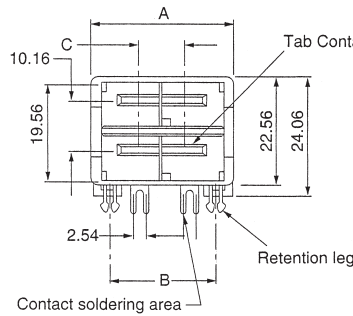
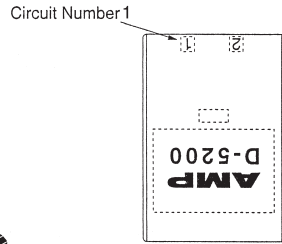
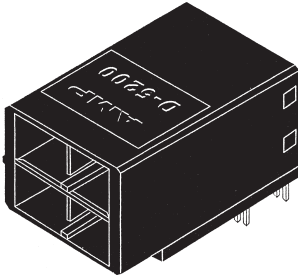

PC Board Layout
 Applicable Board Thickness:
 1.6-2.4±0.1

No. of Pos.	Part Number of Tab Header	Dimensions		
		A	B	C
4	□-1123309-□	29.36	22.86	10.16

Board-mount Tab Header (Horizontal Type)

Mating Receptacle Housing
Part Number:
 □-917807-□

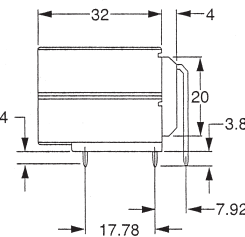
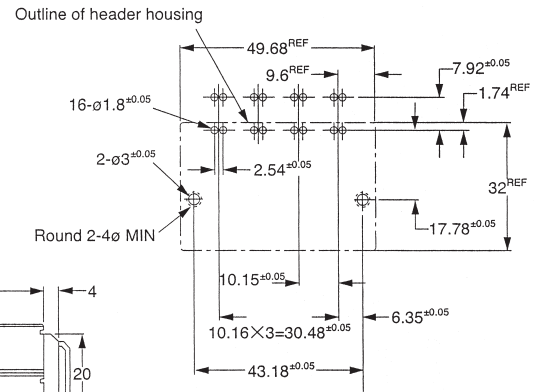
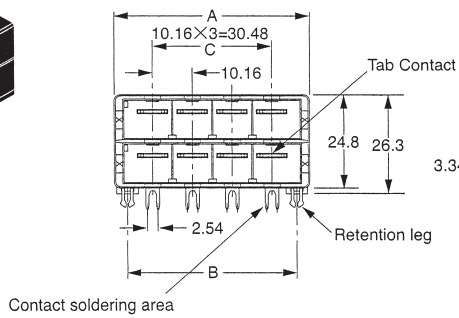
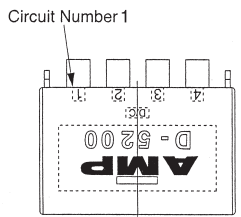
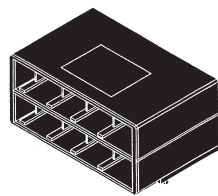

PC Board Layout
 Applicable Board Thickness:
 1.6-2.4±0.1

No. of Pos.	Part Number of Tab Header	Dimensions		
		A	B	C
8	1123829-1	49.68	43.18	30.48

D-5200 Series (Continued)

D-5200M α — High Current Type

Appearance Board mounting pitch: 400mils (10.16mm)
Dielectric Withstanding Voltage: 3,000V (for one minute)
Voltage Rating: 630V AC

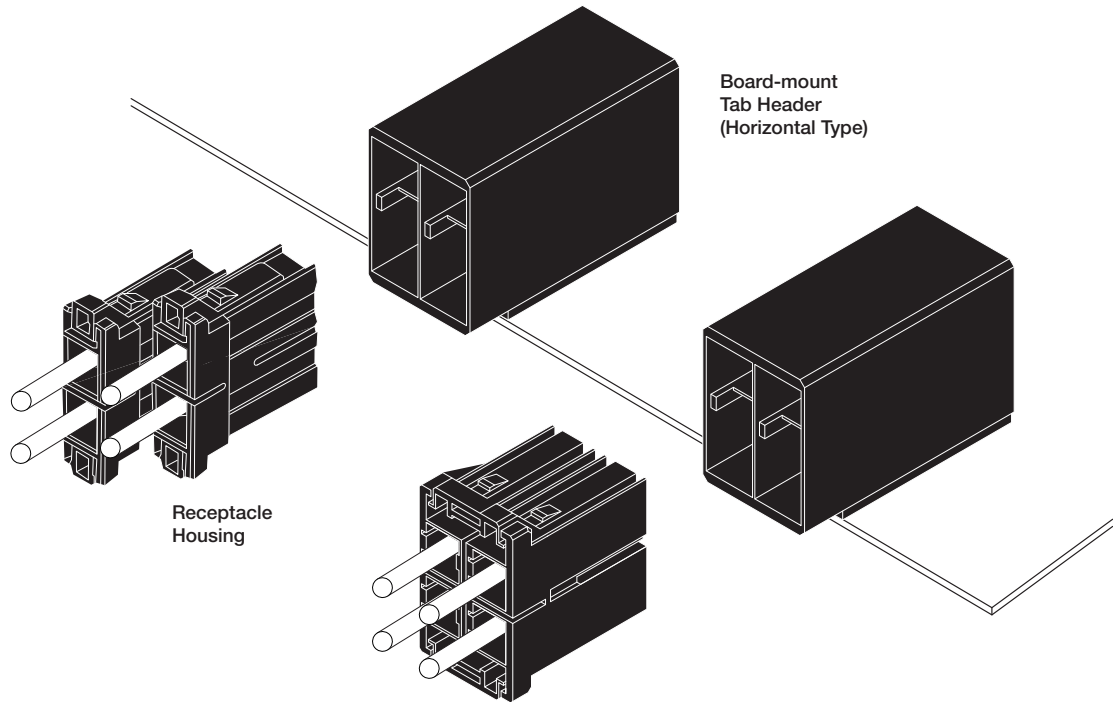

Receptacle Housing

Board-mount Tab Header (Horizontal Type)

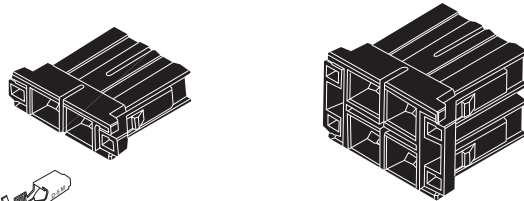

Receptacle Contact, refer to the appropriate pages

Part Number Chart

No. of Pos.	Keying	Part Number of Receptacle Housings	Part Number of Board-mounting Tab Headers (Horizontal Type)
2	X	1-179958-2	—
	Y	2-179958-2	—
4	XX	1-917807-2	1-1318983-6
	YY	2-917807-2	2-1318983-6
	XY	3-917807-2	3-1318983-6

* The 2 pos. receptacles use same 2 pos. housing of D-5200S Series.
The 4 pos. receptacles use same 4 pos. housing of D-5200M Series.
The contacts, however, are D-5 α (Silver plated type).

Keying

Keying is provided with this product (D-5200M α) to help prevent misinsertion. Three types, XX, YY, and XY, are available.

D-5200 Series (Continued)

D-5200M α — High Current
Type (Continued)

Mating Dimensions

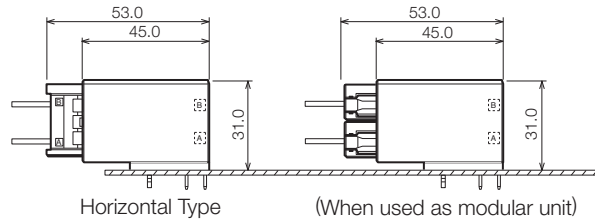

External Dimensions

Receptacle Housing (2 Pos.)

Mating Tab Header
Part Number:
□-1318983-□

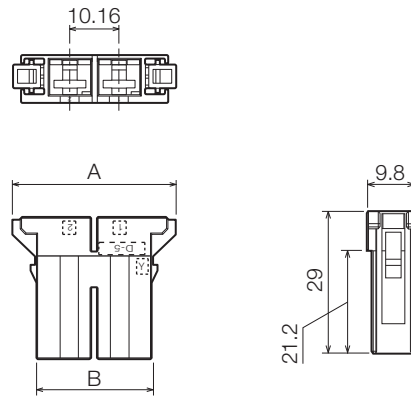
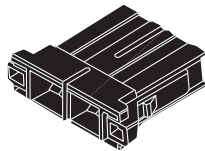

No. of Positions	Keying	Part Number of Receptacle Housing	Dimensions	
			A	B
2	X	1-179958-2	35.76	23.76
	Y	2-179958-2		

Receptacle Housing (4 Pos.)

Mating Tab Header
Part Number:
□-1318983-□

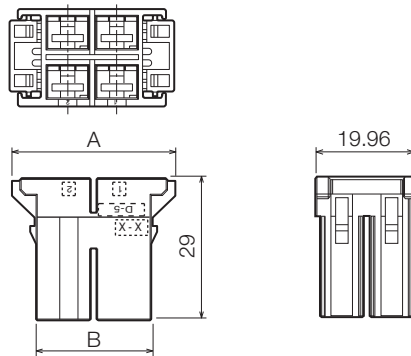
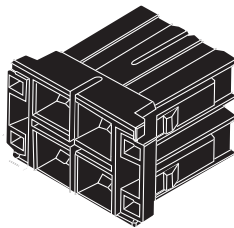

No. of Positions	Keying	Part Number of Receptacle Housing	Dimensions	
			A	B
4	XX	1-917807-2	33.36	23.76
	YY	2-917807-2		
	XY	3-917807-2		

D-5200 Series (Continued)

D-5200M α — High Current
Type (Continued)

Board-mount Tab Header (Horizontal Type)

Mating Receptacle Housing

Part Number:

□-179958-□

□-917807-□

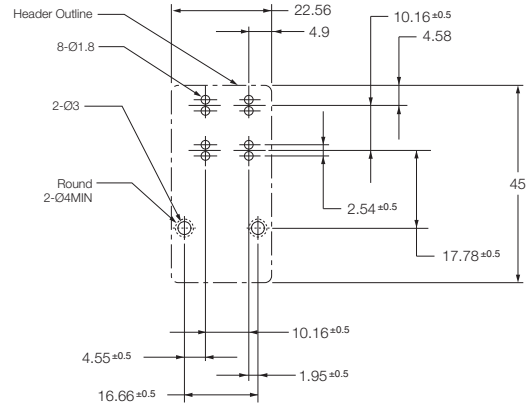
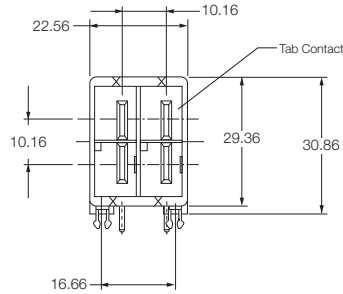
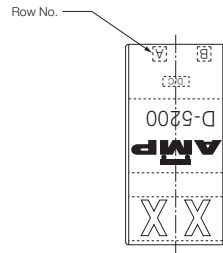
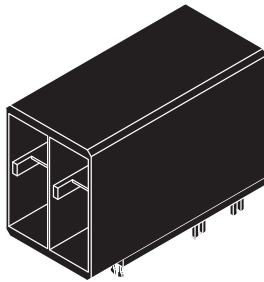

PC Board Layout
Applicable Board
Thickness: 1.6~2.4±0.1

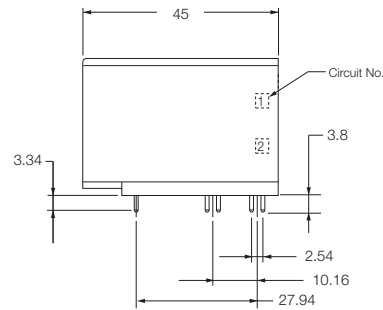

No. of Positions	Keying	Part Number of Tab Header
4	XX	1-1318983-6
	YY	2-1318983-6
	XY	3-1318983-6

DZ-5200 Series (Board-to-Board)

DZ-5200 Series

High-current board-to-board connectors with 30A per contact are useful for cableless control boards.

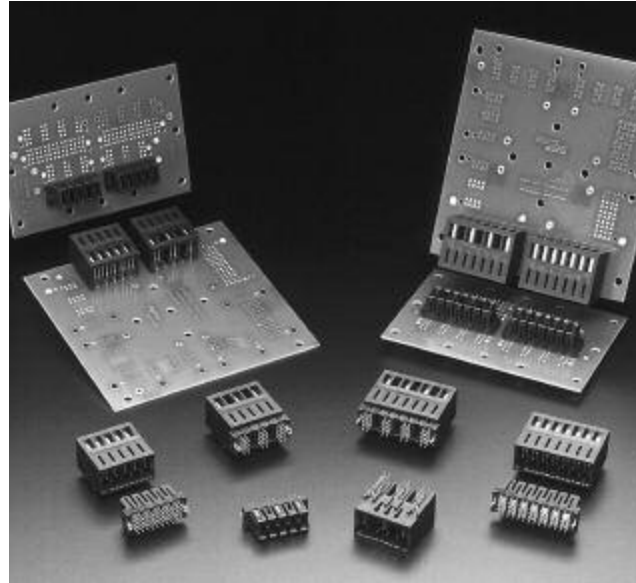

Material and Finish

Receptacle Contact — Phosphor bronze or copper alloy, gold plated with 1.27 μm nickel underplate

Tab Contact — Phosphor bronze or copper alloy, gold plated with 1.27 μm nickel underplate

Tab Post — Copper alloy, tin plated and gold plated with 1.27 μm nickel underplate

Housing — Glass filled polyester (PBT), UL 94V-0

Performance Characteristics

*When connectors are used singly

Pitch — 5.08mm/10.16mm

Voltage Rating —
5.08mm pitch: 250 V (rms);
10.16mm pitch: 600 V (rms)

Current Rating —
5.08mm pitch: 20A;
10.16mm pitch: 30A

Contact Resistance — 10 mΩ max.

Dielectric Withstanding Voltage —
1,500 V (1 minute)

Operating Temperature —
-55°C ~ +105°C

Technical Documents

Product Specification
108-78186

Receptacle Header

Mating Tab Header
Part Number:
□-1747145-□

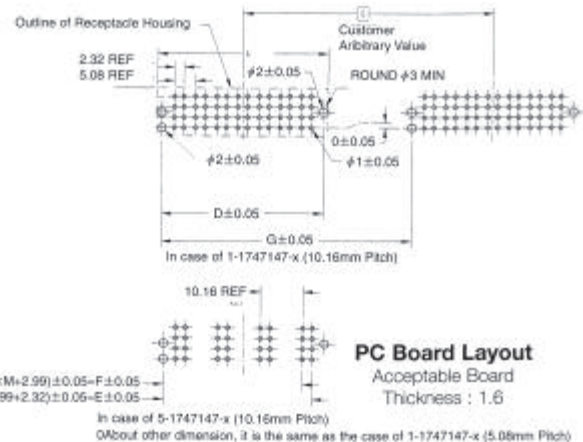
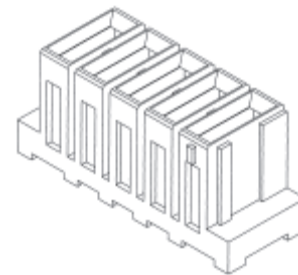
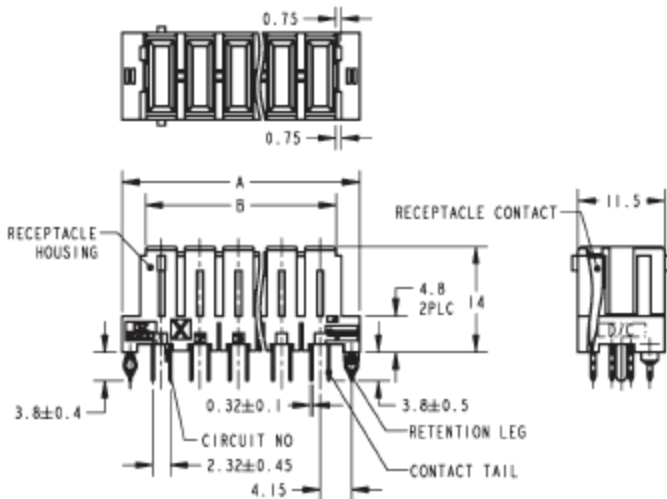

No. of Pos.	Pitch mm	Part Number	Dimensions	
			A	B
3	10.16	5-1747147-3	30.76	24.56
4		5-1747147-4	40.92	34.72
5	5.08	1-1747147-5	30.76	24.56
7		1-1747147-7	40.92	34.27

DZ-5200 Series (Continued)

DZ-5200 Series (Continued)

Tab Header

Mating Receptacle Header

Part Number:

□-1747147-□

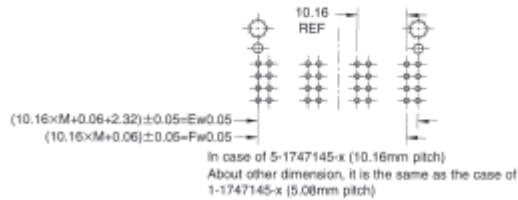
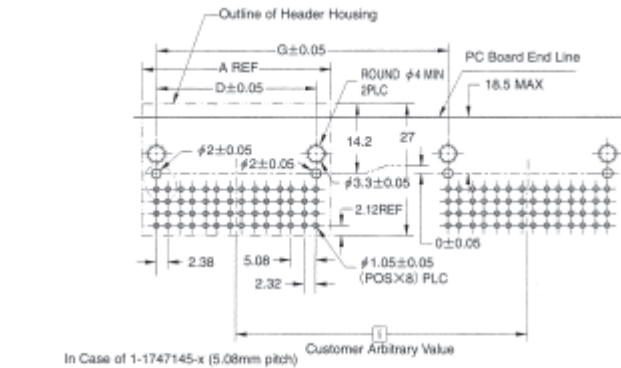
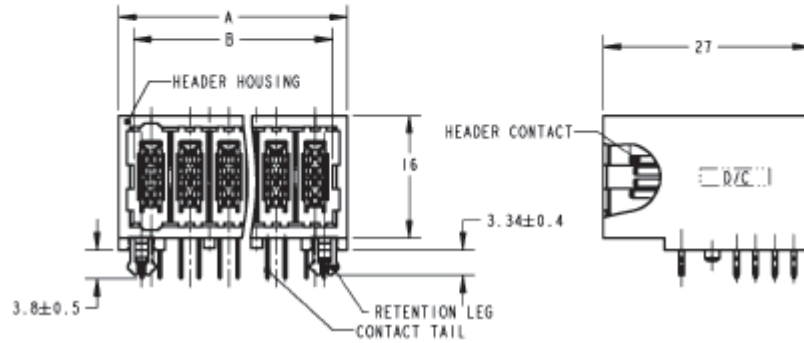
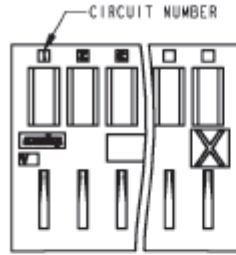
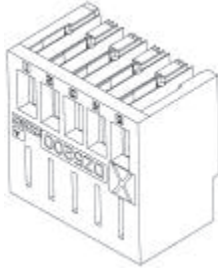

PC Board Layout
Acceptable Board Thickness: 1.6

No. of Pos.	Pitch mm	Part Number	Dimensions	
			A	B
3	10.16	5-1747145-3	28.76	24.86
4		5-1747145-4	38.92	35.02
5	5.08	1-1747145-5	28.76	24.86
7		1-1747145-7	38.92	35.02

D-5300 Series (Wire-to-Panel and Wire-to-Wire)

**D-5300 Series
Reverse Mount Type**

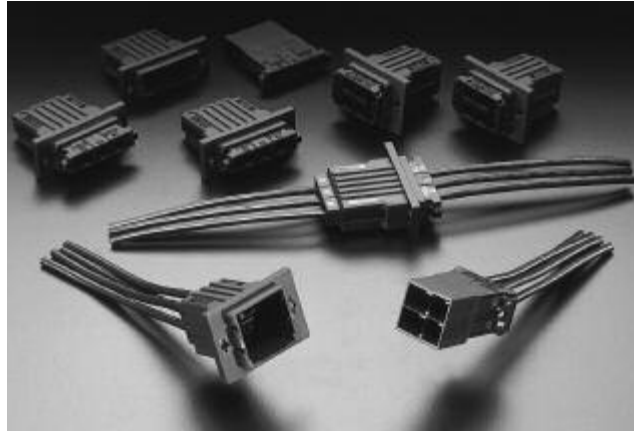

Reverse mount type allows Dynamic Series receptacle contact to be used on panel mount side.

The Dynamic D-5300 Series supports receptacle contact storage demand to conductor housing and such applications where safety standards are important. The receptacle contact satisfies the IP20 rating, which contributes to equipment safety. Plus, a new addition

to the lineup are long tab contacts so contact is made in advance when mating and retains current until completely unmated.

Also, because it uses the D-5000 Series high-current contacts, which have a good reputation in industry, it not only keeps costs for new equipment to a minimum, it also really helps to shorten initial evaluation times.

Material and Finish

Receptacle Contact — Copper alloy, gold plated or silver plated over nickel underplate

Tab Contact — Copper alloy, gold plated or silver plated over nickel underplate

Housing — Glass filled polyester (PBT), UL 94V-0

Performance Characteristics

*When connectors are used singly

Pitch — 400 mil (10.16mm)

Voltage Rating — 630 VAC

Current Rating —
#10: 30A; #12: 25A; #16: 16A

Contact Resistance — 2 mΩ max.

Dielectric Withstanding Voltage —
3,000 V (1 minute)

Operating Temperature —
-55°C ~ +105°C

Related Product Data

D-5 Contact (Refer to page 84)

D-5300 Series (Continued)

D-5300 Series (Continued)

Mating Dimensions

Keying

This product (D-5300) is provided with keying to help prevent mismatching of the connector halves. Keying is available in five types—X Type, Y Type, XX Type, YY Type and XY Type.

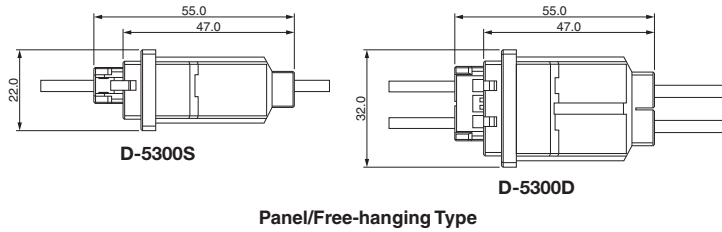

Dimensions

Tab Housing

Panel Mount Type

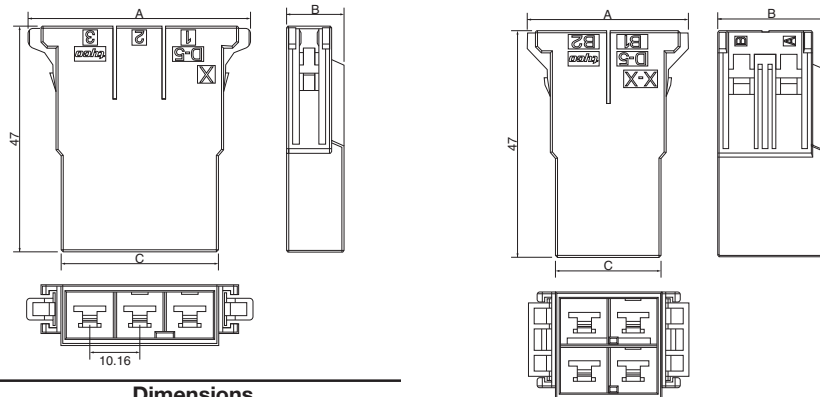

No. of Pos.	Keying	Part Number	Dimensions		
			A	B	C
3	X	1-1747819-3	46.48	12.46	32.68
	Y	2-1747819-3	46.48	12.46	32.68
4	XX	1-1747820-2	33.84	22.62	22.46
	YY	2-1747820-2	33.84	22.62	22.46
	XY	3-1747820-2	33.84	22.62	22.46

Receptacle Housing

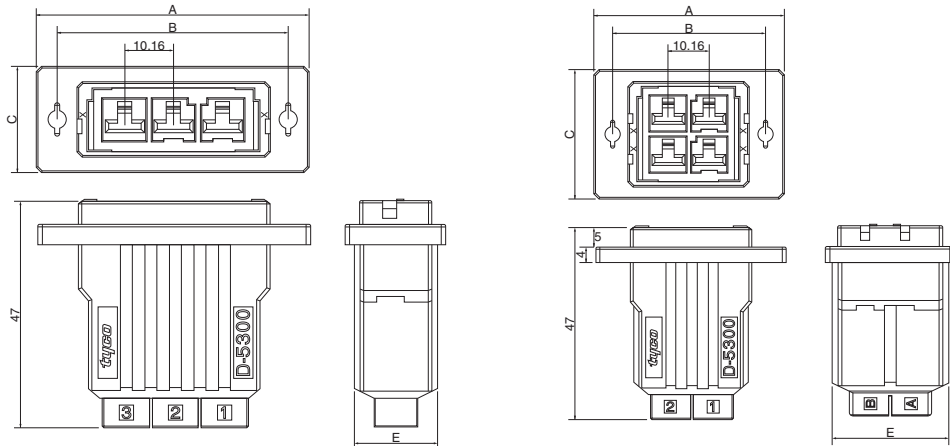

No. of Pos.	Keying	Part Number	Dimensions					
			A	B	C	D	E	F
3	X	1-1747821-3	57	48	22	41.1	18.16	16.8
	Y	2-1747821-3	57	48	22	41.1	18.16	16.8
4	XX	1-1747822-2	47	38	32	30.6	28.32	26.9
	YY	2-1747822-2	47	38	32	30.6	28.32	26.9
	XY	3-1747822-2	47	38	32	30.6	28.32	26.9

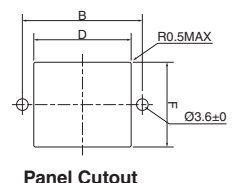

Panel Cutout

D-5000 Series

AMP Dynamic with HTS Connectors (Wire-to-Panel and Wire-to-Wire)

2800/3800 Series

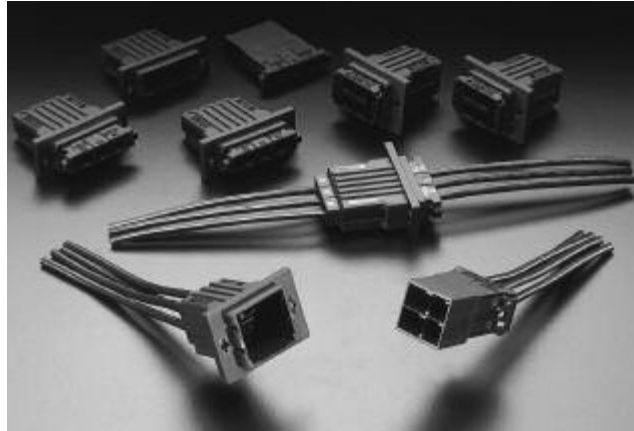

This Series is a combination of the proven HTS series rectangular connectors and the popular Dynamic Series connector line.

Metal hoods and frames of HTS connectors, which offers many choices depending on sizes and mounting styles are employed. Sizes and number of positions can be selected to meet the appli-

cation needs. It is also suitable for high-current applications.

Sequential terminals are available to enable termination with automatic crimping machines. Termination time can be substantially reduced.

Approximately 30% higher density mounting is possible compared to the high density HTS connectors.

Material and Finish

Receptacle Contact — Phosphor bronze or copper alloy, gold plated with 1.27 μ m nickel underplate

Tab Contact — Phosphor bronze or copper alloy, gold plated with 1.27 μ m nickel underplate

Housing — Glass filled polyester (PBT), UL 94V-0

Performance Characteristics

Voltage Rating —

D-2800 Series: 250 V;
D-3800 Series: 600 V

Current Rating —

D-2800 Series: 5A (#18 AWG);
D-3800 Series: 15A (#16 AWG)

Contact Resistance — 10 m Ω max.

Dielectric Withstanding Voltage — 1,500 V (1 minute)

Operating Temperature — -55°C ~ +105°C

Technical Documents

Product Specifications

108-78284
108-78285

Application Specifications

114-5258
114-5148

Contact

Contacts of proven Dynamic Series, as well as the existing special tools and applicators, can continue to be used.

D-2 Contact

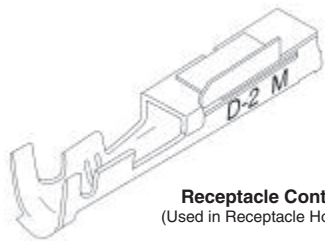

Receptacle Contact
(Used in Receptacle Housing)

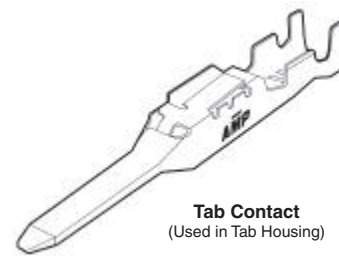

Tab Contact
(Used in Tab Housing)

D-3 Contact

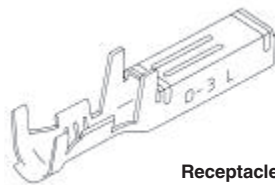

Receptacle Contact
(Used in Receptacle Housing)

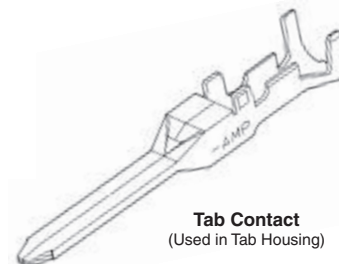

Tab Contact
(Used in Tab Housing)

AMP Dynamic with HTS Connectors (Wire-to-Panel and Wire-to-Wire) (Continued)

2800 Series

Receptacle Housing

No. of Pos.	Part Number
30	1747365-1

Mating Tab Housing
Part Number:
1747366-1

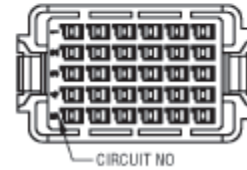
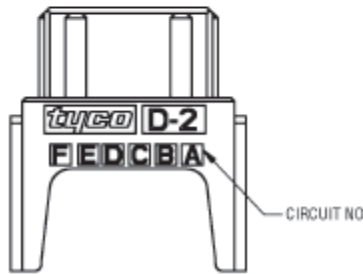
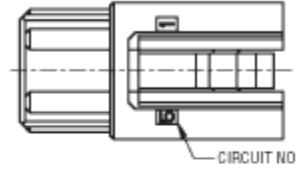
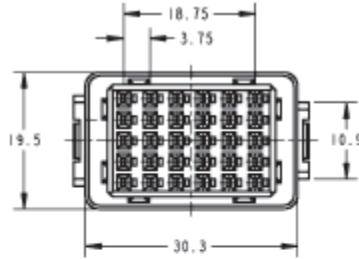

Tab Housing

No. of Pos.	Part Number
30	1747366-1

Mating Receptacle Housing
Part Number:
1747365-1

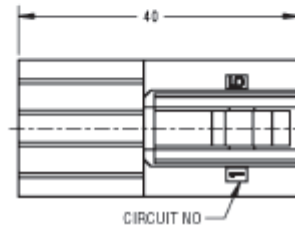
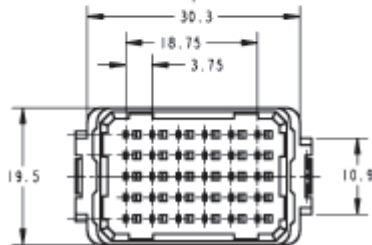
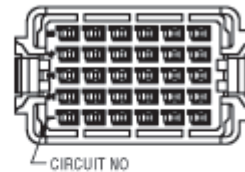
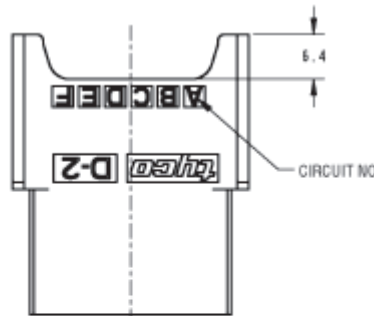

AMP Dynamic with HTS Connectors (Wire-to-Panel and Wire-to-Wire) (Continued)

3800 Series

Receptacle Housing

No. of Pos.	Part Number
12	1747363-1

Mating Tab Housing
Part Number:
1747364-1

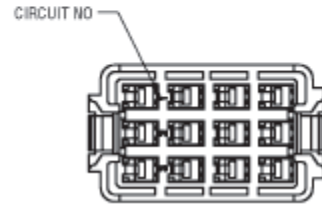
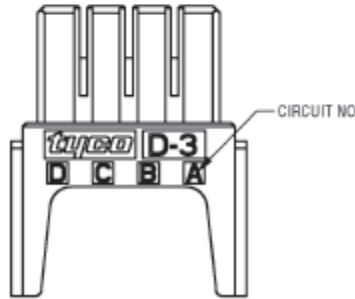
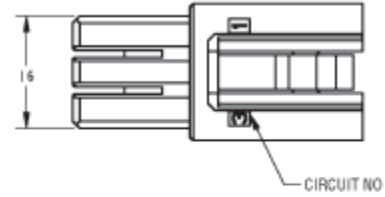
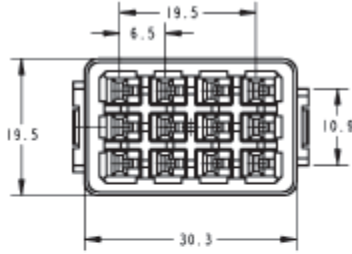

Tab Housing

No. of Pos.	Part Number
12	1747364-1

Mating Receptacle Housing
Part Number:
1747363-1

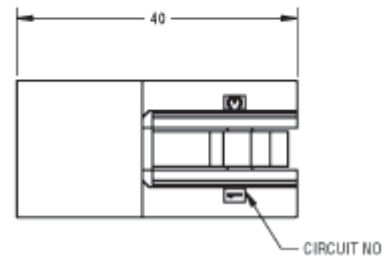
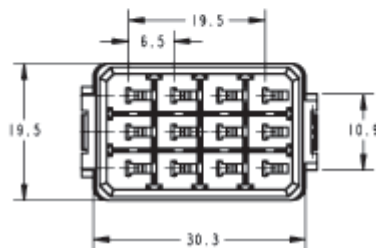
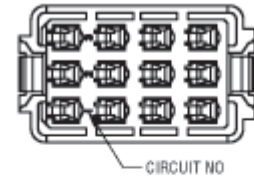
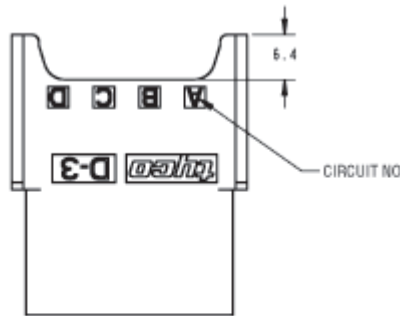

AMP Dynamic with HTS Connectors (Wire-to-Panel and Wire-to-Wire) (Continued)

Frames and Metal Housings

	Frame	Applicable Metal Housing
Size 3 (1 Module Type)		Refer to HTS Catalog 889745-2

Part Number: **1108784-1**

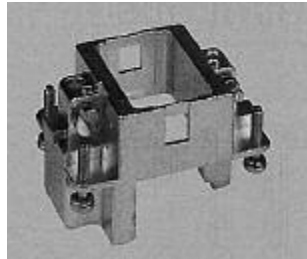

Refer to HTS Catalog 889745-2

Size 4 (2 Module Type)

Part Numbers:
1108783-1 (Male)
1108783-2 (Female)

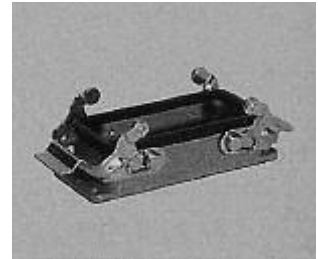
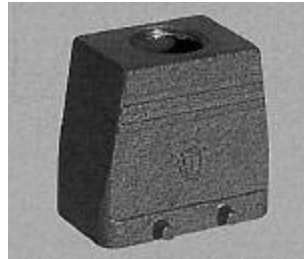
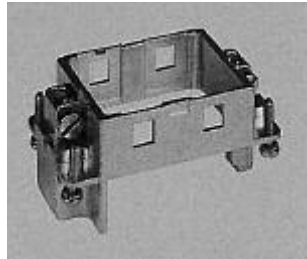

Refer to HTS Catalog 889745-2

Size 6 (3 Module Type)

Part Numbers:
1108782-1 (Male)
1108782-2 (Female)

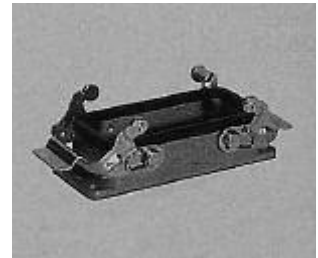
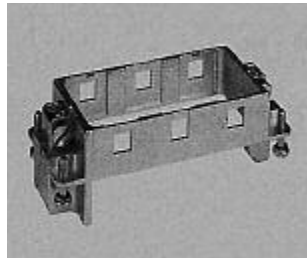

Refer to HTS Catalog 889745-2

Size 8 (4 Module Type)

Part Numbers:
1108780-1 (Male)
1108780-2 (Female)

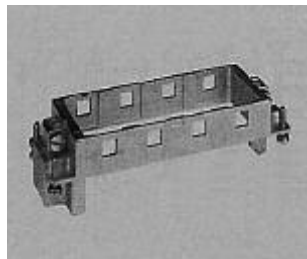

Refer to HTS Catalog 889745-2

AMP Dynamic with HTS Connectors

AMP Dynamic with HTS Connectors (Wire-to-Panel and Wire-to-Wire) (Continued)

Cable Fittings

Plastic Type

Gland fitting IP 68 plastic

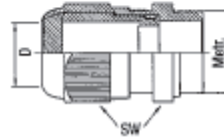
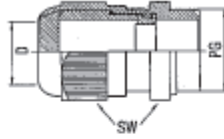

PG	D		SW	Designation	Part Number
	Min.	Max.			
11	5	10	22	HUT.11.P	1-1106005-7
13.5	6	12	24	HUT.13.P	2-1106005-7
16	10	14	27	HUT.16.P	3-1106005-7
21	13	18	33	HUT.21.P	4-1106005-7
29	18	25	42	HUT.29.P	5-1106005-7
36	22	32	53	HUT.36.P	6-1106005-7
42	32	38	60	HUT.42.P	7-1106005-7

Metr.	D		SW	Designation	Part Number
	Min.	Max.			
M16	4	8	20	HUT.M16.P	1-1102771-6
M20	6	12	24	HUT.M20.P	2-1102771-0
M25	10	14	29	HUT.M25.P	2-1102771-5
M32	13	18	36	HUT.M32.P	3-1102771-2
M40	18	25	46	HUT.M40.P	4-1102771-0
M50	22	32	55	HUT.M50.P	5-1102771-0

Metal Type

Gland fitting IP 68 brass, nickel plated neoprene sealing insert and O-ring at connection thread.

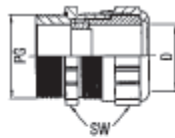

PG	D		SW	Designation	Part Number
	Min.	Max.			
11	5	10	20	HUT.11.MS	1-1106006-9
13.5	6	12	22	HUT.13.MS	2-1106006-9
16	10	14	24	HUT.16.MS	3-1106006-9
21	13	18	30	HUT.21.MS	4-1106006-9
29	18	25	40	HUT.29.MS	5-1106006-9
36	22	32	50	HUT.36.MS	6-1106006-9
42	32	38	57	HUT.42.MS	7-1106006-9

Metr.	D		SW	Designation	Part Number
	Min.	Max.			
M16	5	10	17	HUT.M16.P	1-1102770-6
M20	6	12	22	HUT.M20.P	2-1102770-0
M25	13	18	27	HUT.M25.P	2-1102770-5
M32	18	25	34	HUT.M32.P	3-1102770-2
M40	22	32	43	HUT.M40.P	4-1102770-0
M50	32	38	55	HUT.M50.P	5-1102770-0

Note: Variable options are available other than those listed above. Please refer to HTS Catalog 889745-2.

Power Connector for Board-to-Board Application

Can be used for tab contact connection.
Besides, board can be directly inserted into this connector.

Material & Finish	Housing: Glass-filled thermoplastic, blue Contact: Copper alloy, plated gold (1.27 μm thick) on contact area and tin on post area Tab Contact: Brass, 1.27 μm plated gold
Current Rating	20A
Operating Temperature	-55°C ~ +85°C
Insertions and Extractions	30 times

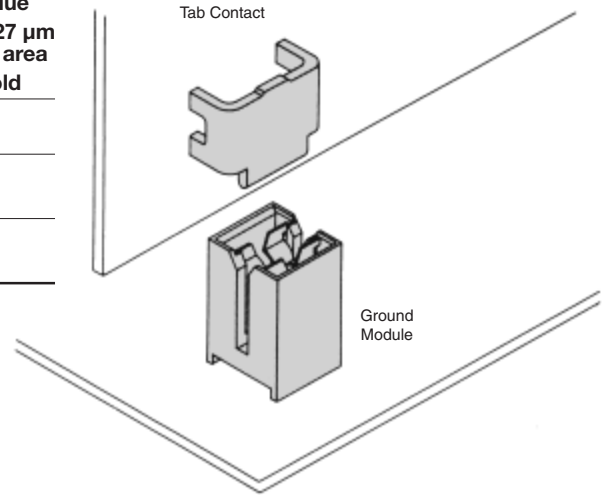

Ground Module



Part Number
119341-1

Tab Contact

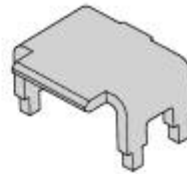

Part Number
175145-2

Application

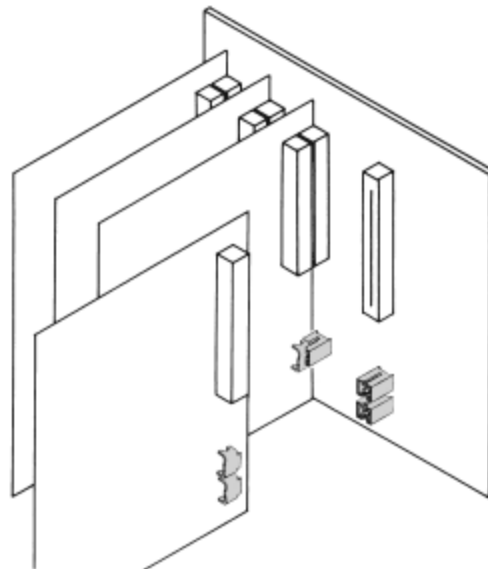

Power Connector for Board-to-Board Application (Continued)

Mating Dimensions

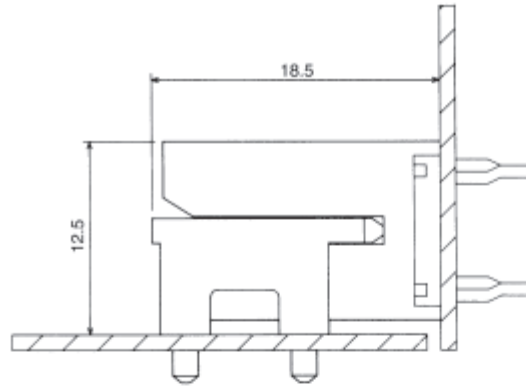

External Dimensions

Ground Module

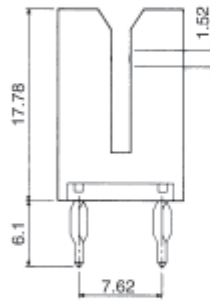
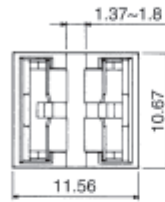
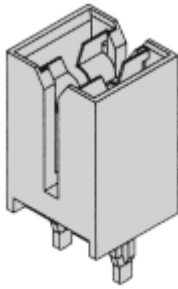

Applicable Board Thickness: 1.37~1.8

Part Number
119341-1

Tab Contact

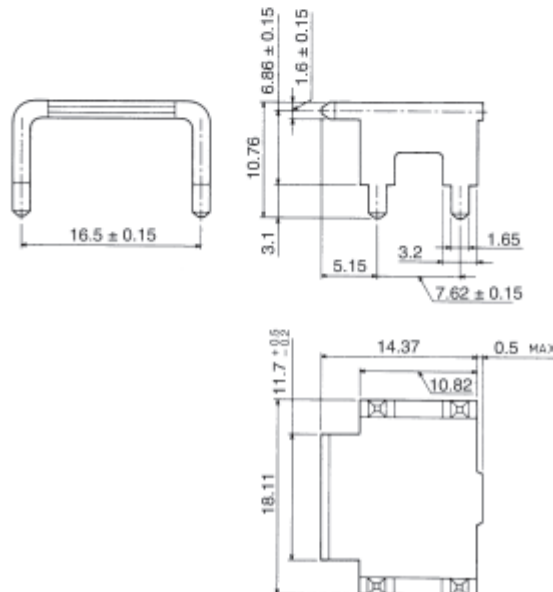
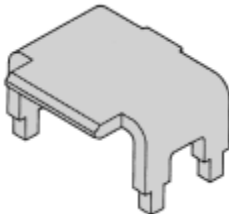

Part Number
175145-2

Dyna-Tap Connectors (Wire-to-Panel and Wire-to-Wire)

Product Facts

- As many Dyna-Tap Connectors will be fixed on casings where dust protection will be needed, dust covers are incorporated into the design. With the dust cover, this connector can be applied in various environments

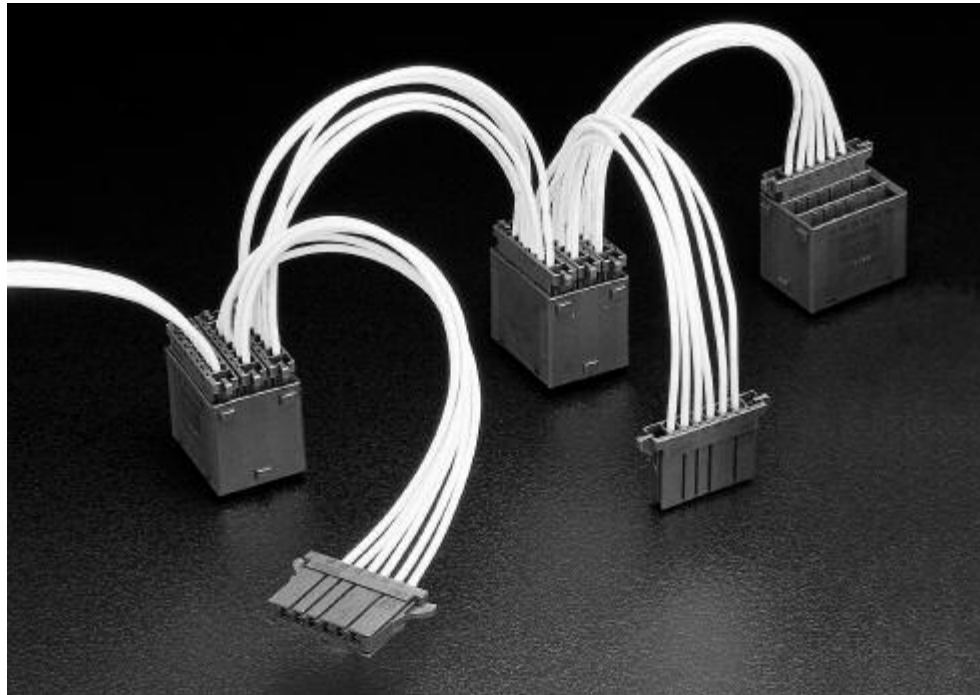

Many pieces of FA equipment are produced by assembling sub-units with divided functions in the final assembly line. Power for each sub-unit of conventional equipment is branched from the power supply bus line over a printed circuit board. In order to save valuable printed circuit board space, Tyco Electronics has developed Dyna-Tap Connectors from which power can be tapped without printed circuits.

Dyna-Tap Connectors are a part of Dynamic Series, which are developed as power supply connectors. Dyna-Tap Connectors are optimized for branching power from the power supply bus line.

In order to cope with three power systems, which are the most popular in the industry, 6-position connectors are specified.

Product Lineup

Free-hanging type and panel mount type are available. The part number of the mating connector is 1-178288-6.

Applications

- Power taps in elevator towers
- Power taps for power protective relays
- Power taps among sub-units of semiconductor producing equipment
- Power supplies for equipment on production lines

Performance Characteristics

Voltage Rating — 250 VAC

Current Rating — 8A (18-position, with AWG#14)

Position — 6 pos. x 3 = 18 pos.

Durability — 500 cycles

Technical Document

Product Specification
108-5754

Dyna-Tap Connectors (Wire-to-Panel and Wire-to-Wire) (Continued)

Mating Dimensions

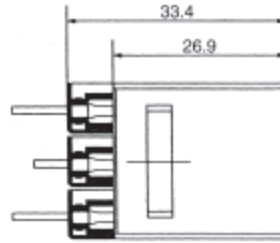

Tab Housings (18-Position)

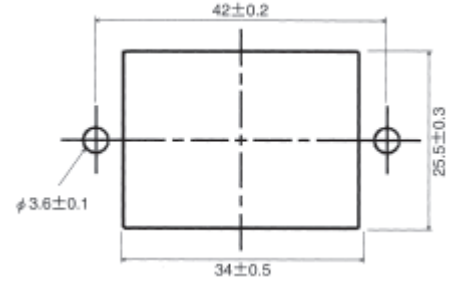

Free-Hanging Type Part Number 1376807-1

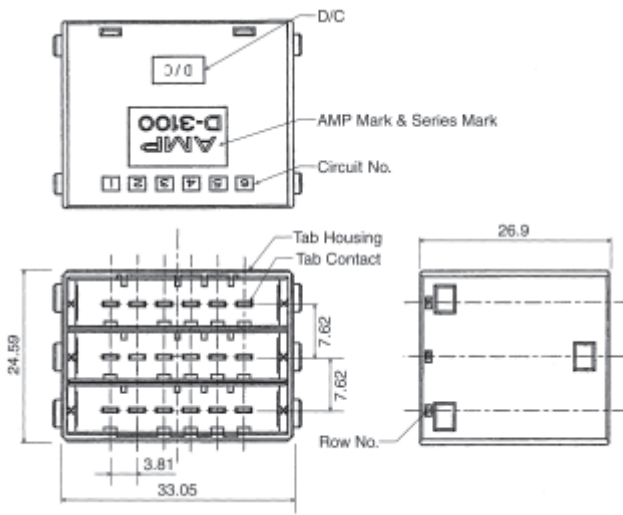

Panel Mount Type Part Number 1376807-2

Panel Cutout
When mounting panel from the front, apply clamping torque of less than 49N [11 lbf].

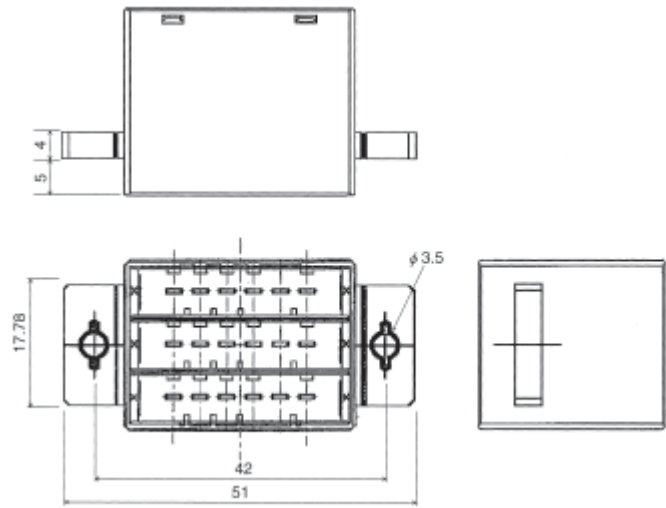

Mating Receptacle Housing (6-Position)

Part Number 1-178288-6

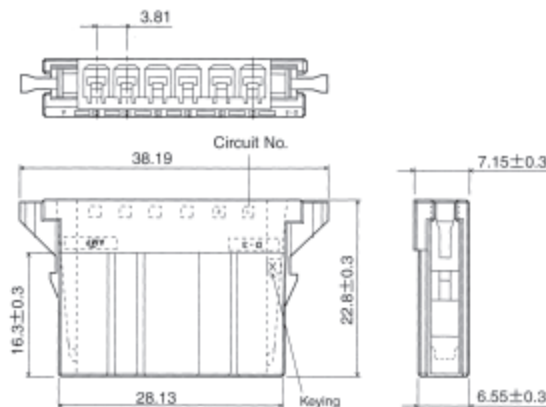
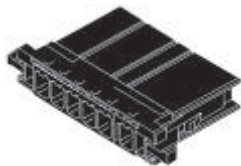

Caution:

Dynamic Series contacts are available either with gold plating or tin plating. However, Dyna-Tap Contacts are only available with 0.38 μm thick gold plating. Mating gold plated contacts with tin plated contacts will cause electrolytic corrosion. Therefore, please choose gold plated contacts for the mating Dyna-Tap Connectors.

Dyna-Tap Connectors (Wire-to-Panel and Wire-to-Wire) (Continued)

D-3000 Series
D-3200 Series Dyna-Tap
24P (4P x 6 Row)

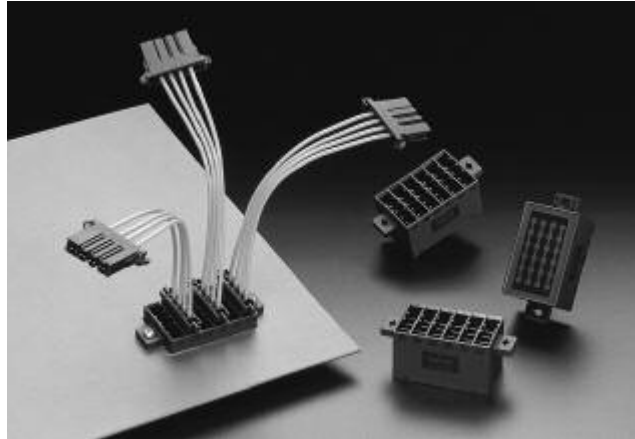

D-3200 4P common series are lined up in six rows.

Issues about branching maintenance and cost are handled with connectors.

The Dynamic Series power supply tap is known for its superior contact reliability. Compared to a terminal block it is possible to reduce installation and maintenance costs. Also, because the circuits are electronically commoned, circuit board and connector do not need to be mounted. This leads to reductions in number of components and man hours as well as an overall decrease in costs.

Material and Finish

Receptacle Contact — Copper alloy, plated gold or tin over nickel underplate

D-3 Contact — Copper alloy, plated gold or tin over nickel underplate

Tab Post — Copper alloy, plated 0.38 µm gold or 2.0 µm tin over 1.3 µm nickel underplate

Housing — Glass filled polyester (PBT), UL 94V-0

Performance Characteristics*

Pitch — 200 mil (5.08 mm)

Voltage Rating — 600 VAC

Current Rating —
24-position: 10 A Max.

Contact Resistance — 10 mΩ Max.

Dielectric Withstanding Voltage —
2,200 VAC (1 minute)

Operating Temperature —
-55°C ~ +105°C

*When connectors are used singly.

Related Product Data

D-3 Contact (Refer to page 101)

Dyna-Tap Connectors (Wire-to-Panel and Wire-to-Wire) (Continued)

**D-3200 Series Dyna-Tap
24P (4P x 6 Row) (Continued)**

Mating Dimensions

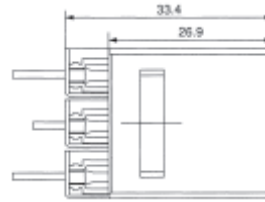

Panel/Free-hanging Type

**Dimensions
Receptacle Housing**

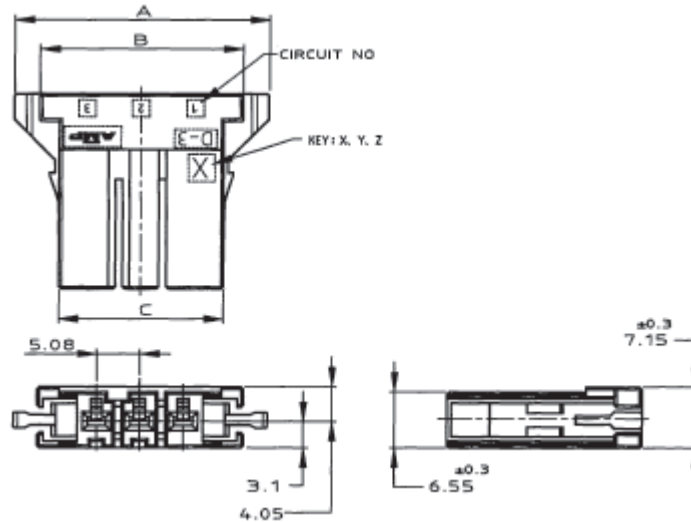

No. of Pos.	Part Number	Dimensions		
		A	B	C
3	1-178128-3	29.70	24.10	19.24

Tab Housing

Panel Mount Type

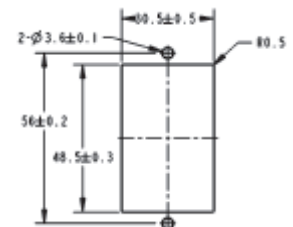
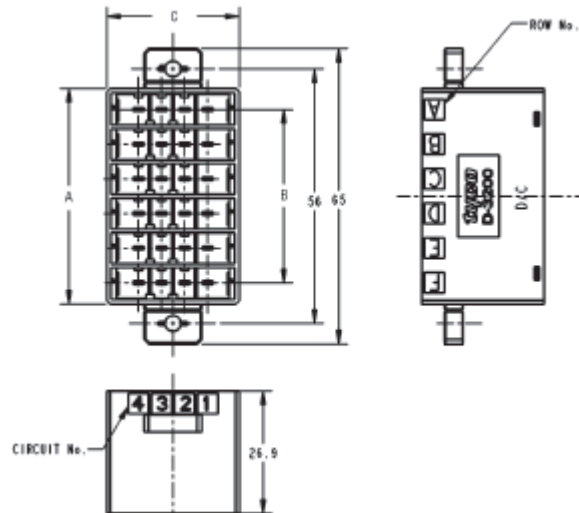

Panel Cutout

Free-hanging Type

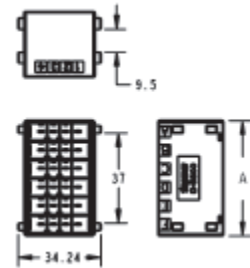

No. of Pos.	Plating	Part Number		Dimensions		
		Panel Mount Type	Free-hanging Type	A	B	C
24	0.38 μ m Gold	1827691-2	1827691-1	47.45	38.1	29.24
	2.0 μ m Tin	1-1827691-2	1-1827691-1			

Dyna-Clamp Kit (Wire-to-Board, Wire-to-Panel and Wire-to-Wire)

Most connectors mounted outside of many pieces of FA equipment are made of metal because of their robustness. Connectors made of metal have a very high performance level.

However, connectors made of metal are more costly than connectors made of plastics.

Tyco Electronics has added a cable clamp function to the existing Dynamic Series. With this new design, the robustness of Dynamic Series connectors made of plastic has been improved remarkably.

This lower cost connector can contribute to the total cost reduction of end products.

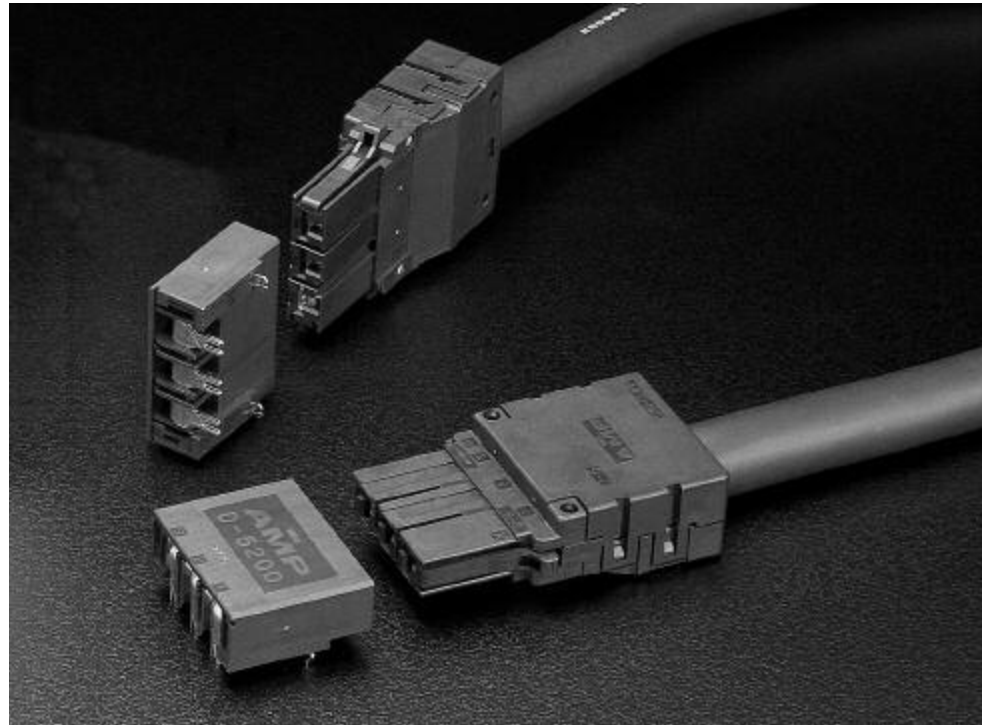

Applications

- Power supply I/Os among sub-units of semiconductor producing equipment
- Power supply I/Os for control panels
- Power supply I/Os for power control panels
- Power supply I/Os for robots

Product Lineup

This 3-position connector was developed from the Dynamic Connector 5200 as its basis to realize low-cost 30 A class power distribution for FA equipment. The existing contacts can be used, which means the existing production method such as crimping tools or automatic machines can be utilized without any change.

Support for Obtaining UL, TÜV Approvals

It is more favorable to obtain UL and TÜV approvals with this connector than with metal connectors because of the following reasons:

Made of Plastic

Because of the plastic connector, ground wire at power supply is not necessary. This simplifies wirings of FA equipment and leads to lowering the total cost.

Sequential Structure

A sequential structure is designed so that the ground wire is always electrically connected before power lines.

Performance Characteristics

Voltage Rating — 6300 VAC

Current Rating — 30 A

Position — 3 pos.

Durability —

With 0.38 μm contact: 50 cycles
With 0.76 μm contact: 100 cycles

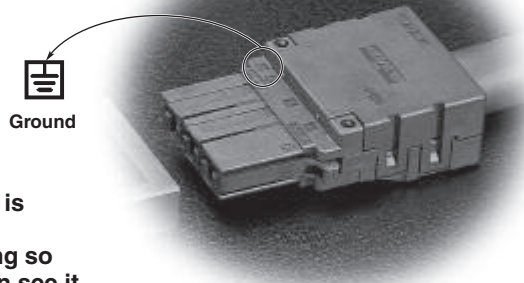

The ground mark is embossed on the connector housing so that operators can see it.

Dyna-Clamp Kit (Wire-to-Board, Wire-to-Panel and Wire-to-Wire) (Continued)

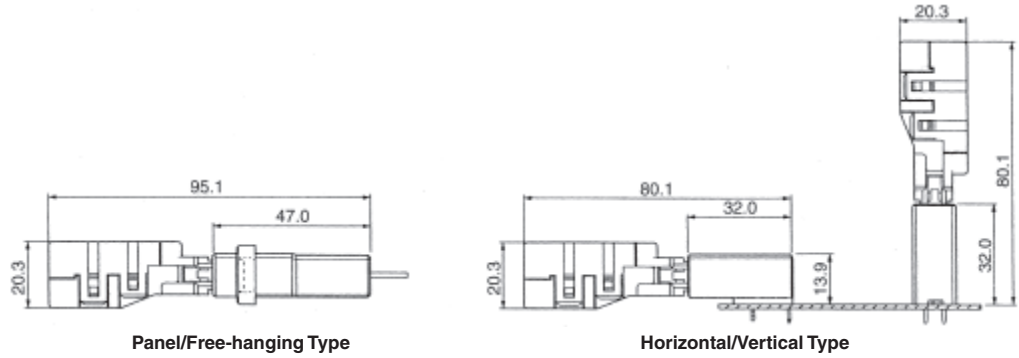

Cable Kit

Part Number 1473668-1

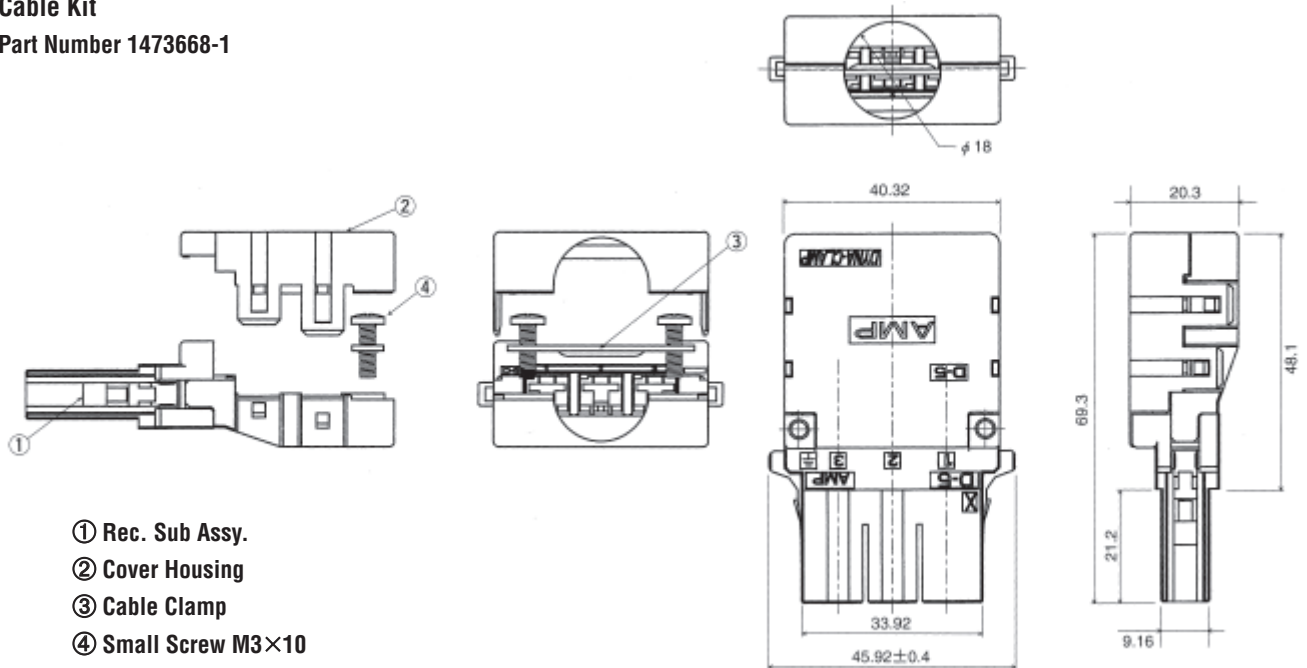

- ① Rec. Sub Assy.
- ② Cover Housing
- ③ Cable Clamp
- ④ Small Screw M3×10

Mating Connectors

Tab Housing

Board Mounting Tab Header

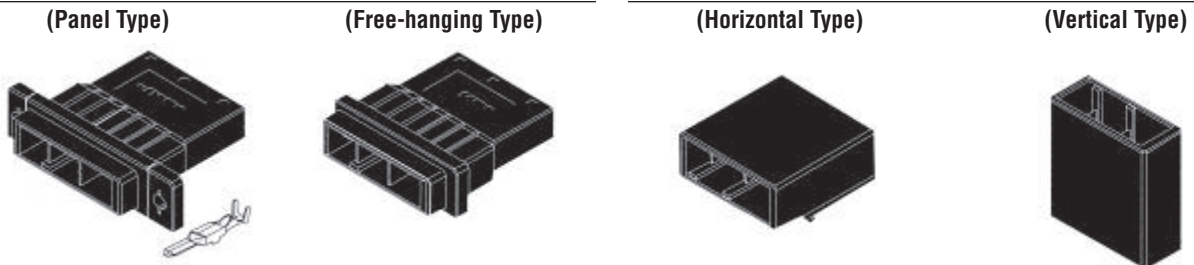

Tab Contact.....For each line of contacts, refer to the appropriate page

No. of Pos.	Part Number of Tab Housing		Board Mounting Tab Header	
	Panel Type	Free-hanging Type	Horizontal Type	Vertical Type
3	1-353047-3	1-353046-3	1-353081-□	1-353082-□

Note: Enter the following plating codes in -□ after Part Numbers:
 -2 = 0.38 μm thick gold plating, -3 = 0.76 μm thick gold plating

Part Number Index

Note: This index lists all cataloged parts by base no. only. Complete part nos. (with prefixes and/or suffixes) are shown on the page(s) indicated.

Part No.	Page	Part No.	Page	Part No.	Page
84695	84	178328	49-51	917804	84
84696	84	178802	43, 45	917805	84
119341	106, 107	178803	49, 50	917807	90, 92-96
175145	106, 107	178964	49, 50	917808	90, 92
175194	38	179129	64	917809	90, 92
175195	38	179188	47, 48	1102770	105
175196	38	179276	56, 58, 59	1102771	105
175216	38	179277	56, 58, 59	1106005	105
175217	38	179552	56, 58	1106006	105
175218	38	179553	56, 58	1108780	104
175284	38	179554	62, 64, 66, 67	1108782	104
175285	38	179555	62, 64, 66, 67	1108783	104
175286	38	179955	84	1108784	104
175287	38	179956	84	1123309	90, 92, 93
175288	38	179958	86, 88, 89, 94-96	1123624	69
175289	38	179959	86, 88, 89	1123829	90, 92, 93
175362	73, 74, 75	179960	86, 88, 89	1318095	73, 74, 75
175363	73, 74, 75	179993	85	1318105	19
175365	73, 74, 75	316040	84	1318106	19
176346	76, 77	316041	84	1318107	19
177555	73, 75	316080	62, 64, 65	1318108	19
177555	74	316081	62, 64, 65	1318109	19
177648	43, 45	316130	56, 58, 59	1318110	19
177662	47, 48	316131	56, 58, 59	1318111	19
177665	47, 48	316132	56, 58, 59	1318112	19
177988	47	316133	56, 58, 59	1318114	24, 26
178127	52-55	316516	73-75	1318115	24, 26
178128	56, 58-61, 69, 111	316517	73-75	1318116	20, 22
178129	62, 64, 65	350381	86	1318117	20, 22
178136	56, 58, 59	353046	86, 88, 113	1318118	24, 26, 27
178137	52-55	353047	86, 88, 113	1318119	24, 26, 27
178138	56, 58, 59	353079	86, 88, 89	1318120	20, 22, 23
178139	62, 64-68	353080	86, 88, 89	1318123	20, 22, 23
178140	62, 64-68	353081	86, 88, 89, 113	1318124	24, 26, 27
178141	52, 53-55	353082	86, 88, 89, 113	1318125	24, 26, 27
178214	70-72	353715	38	1318126	24, 26, 27
178216	70-72	353716	38	1318127	24, 26, 27
178288	43, 45-48, 53, 109	353717	38	1318577	28-30
178289	49-51	353718	38	1318578	28, 29, 31
178293	43, 45, 46, 53	900121	42	1318579	28-30
178294	43, 45, 46	900128	42	1318696	84
178295	43, 45, 46	900167	28, 30, 66	1318697	84
178296	43, 45, 46	917226	67	1318983	94-96
178297	43, 45, 46	917241	73, 74	1318985	84
178298	43, 45, 46	917242	73, 74	1318986	84
178303	49-51	917249	70-72	1376009	24, 26, 27
178304	50	917251	70-72	1376020	24, 26, 27
178305	49-51	917266	66-68	1376059	28, 30
178306	49-51	917337	56, 58, 59	1376072	28, 29, 31
178307	49-51	917338	56, 58, 59	1376073	28, 31
178308	49-51	917389	60, 61	1376133	73-75
178313	43, 45, 46, 53	917484	38	1376135	20, 22, 23
178314	43, 45, 46	917485	38	1376136	24, 26, 27
178315	43, 45, 46	917511	38	1376137	24, 26, 27
178316	43, 45, 46	917512	38	1376807	109
178317	43, 45, 46	917541	86, 88, 89	1473074	20, 22, 23
178318	43, 45, 46	917542	86, 88, 89	1473668	113
178323	49-51	917657	62, 64, 65	1717412	49, 50, 51
178324	50	917658	62, 64, 65	1747145	97, 98
178325	49-51	917659	62, 64, 65	1747147	97, 98
178326	49-51	917802	84	1747276	79, 80
178327	49-51	917803	84	1747277	79, 80

Part Number Index (Continued)

Part No.	Page	Part No.	Page	Part No.	Page
1747363	103	1827572	7	1871731	7
1747364	103	1827579	14	1871743	7
1747365	102	1827581	14	1871744	7
1747366	102	1827583	15	1871745	7
1747414	79	1827586	7	1903111	7
1747415	78	1827587	7	1903112	7
1747416	78	1827588	7	1903113	7
1747418	78	1827589	7	1903114	7
1747419	78	1827691	111	1903115	7
1747498	78	1827862	8	1903116	7
1747499	78	1827863	8	1903117	7
1747500	78	1827864	12	1903118	7
1747501	78	1827872	9	1903120	7
1747535	79	1827873	9	1903121	7
1747819	100	1827875	12	1903122	7
1747820	100	1827876	13	1903124	7
1747821	100	1871056	9	1903125	7
1747822	100	1871057	8	1903126	7
1747994	24, 26, 27	1871303	7	1903127	8
1827538	33	1871304	7	1903128	8
1827540	33	1871315	9	1903129	11
1827569	7	1871465	10	1903130	13
1827570	7	1871468	10	1903131	13
1827571	7	1871673	13		

Application Tooling Part Number Index

Note: This index lists all cataloged parts by base no. only. Complete part nos. (with prefixes and/or suffixes) are shown on the page(s) indicated.

Part No.	Page	Part No.	Page	Part No.	Page
58571	39	234172	37	1762626	7
91558	38	409158	84	1762846	7
91559	38	919041	41	1762847	7
91560	38	919600	37	1762950	7
91561	38	919601	37	1762951	7
91565	38	919602	37	1762952	7
91576	18, 19	1366044	83, 84	1762953	7
91595	18, 19	1366656	83	1891033	7
91596	83, 84	1762119	78	1891035	7
175855	41	1762120	78	1891036	7
234168	41	1762129	78	1891037	7
234170	83, 84	1762130	78		
234171	83, 84	1762625	7		

Engineering Notes



Engineering Notes



Engineering Notes

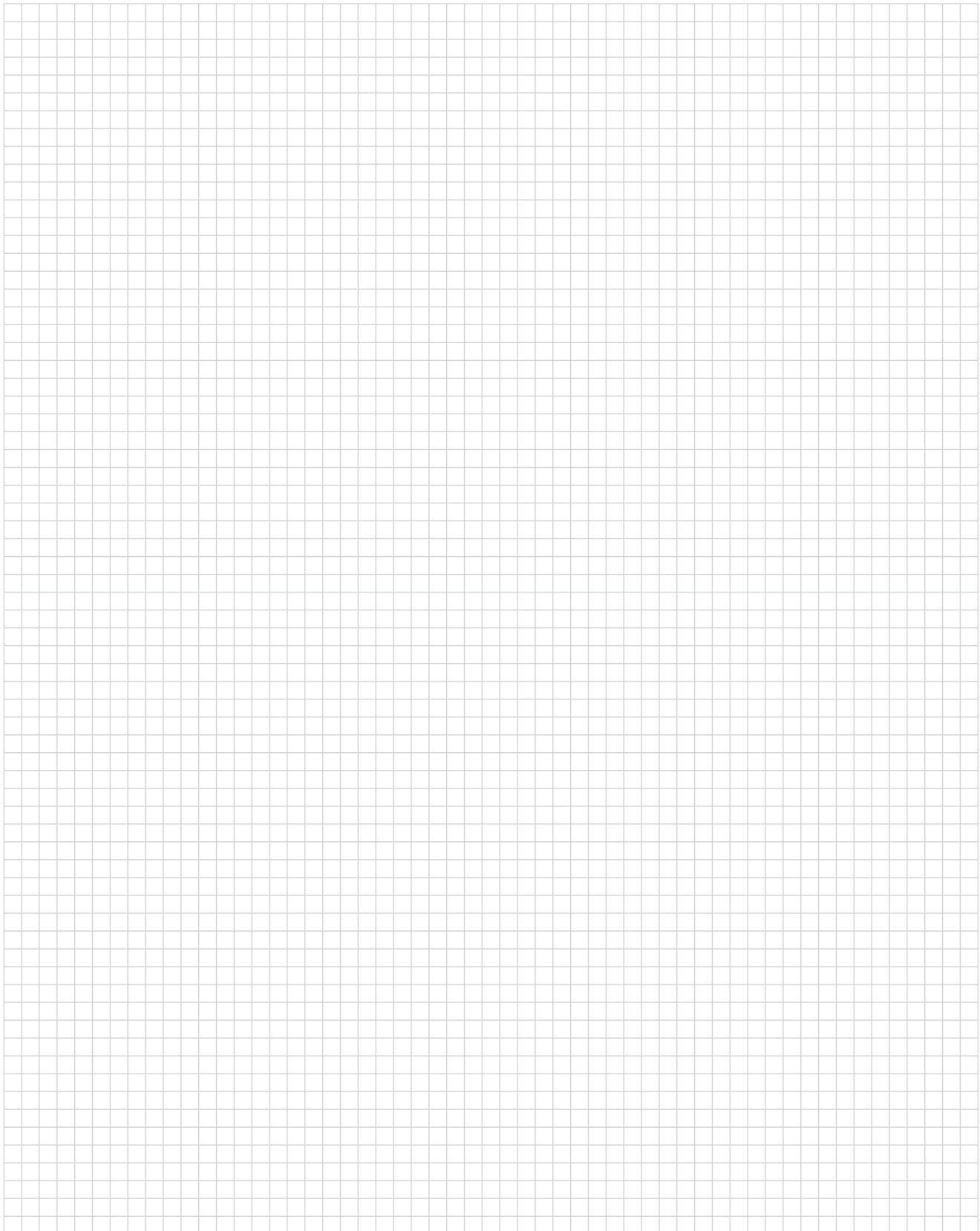

Americas

Argentina – Buenos Aires
 Phone: +54-11-4733-2200
 Fax: +54-11-4733-2211

Brasil – São Paulo
 Phone: +55-11-3611-1311
 Fax: +55-11-3611-0397

Canada – Toronto
 Phone: +905-475-6222
 Fax: +905-474-5520

**Product Information Center:
 (Technical Support)**
 Phone: +905-470-4425
 Fax: +905-474-5525

Colombia – Bogota
 Phone: +57-1-231-9398
 Fax: +57-1-660-0206

Mexico – Mexico City
 Phone: +52-55-1106-0800
 +01-800-733-8926
 Fax: +52-55-1106-0901

United States – Harrisburg, PA
 Phone: +717-564-0100
 Fax: +717-986-7575
**Product Information Center:
 (Technical Support)**
 Phone: +800-522-6752
 Fax: +717-986-7575

**For Latin/South American
 Countries not shown**
 Phone: +54-11-4733-2015
 Fax: +54-11-4733-2083

Asia/Pacific

Australia – Sydney
 Phone: +61-2-9554-2600
 Fax: +61-2-9502-2556
**Product Information Center:
 (Technical Support)**
 Phone: +61-2-9840-8200
 Fax: +61-2-9634-6188

India – Bangalore
 Phone: +91-80-285-40800
 Fax: +91-80-285-40820

Indonesia – Jakarta
 Phone: +65-6482-0311
 Fax: +65-6482-1012

Japan – Toyko
 Phone: +81-44-844-8111
 Fax: +81-44-812-3207
**Product Information Center:
 (Technical Support)**
 Phone: +81-44-844-8013
 Fax: +81-44-812-3200

Korea – Seoul
 Phone: +82-2-3415-4500
 Fax: +82-2-3486-3810

Malaysia – Kuala Lumpur
 Phone: +60-3-78053055
 Fax: +60-3-78053066

New Zealand – Auckland
 Phone: +64-9-634-4580
 Fax: +64-9-634-4586

Philippines – Makati City
 Phone: +632-848-0171
 Fax: +632-867-8661

People's Republic of China
 Hong Kong
 Phone: +852-2735-1628
 Fax: +852-2735-0243

Shanghai
 Phone: +86-21-2407-1588
 Fax: +86-21-2407-1599

Taiwan – Taipei
 Phone: +886-2-8768-2788
 Fax: +886-2-8768-2268

Singapore – Singapore
 Phone: +65-6482-0311
 Fax: +65-6482-1012

Thailand – Bangkok
 Phone: +66-2-955-0500
 Fax: +66-2-955-0505

Vietnam and Indochina –
 Ho Chi Minh City
 Phone: +84-8 930-5546
 Fax: +84-8 930-3443

Europe/Middle East/Africa

Austria – Vienna
 Phone: +43-1 90 5 60-0
 Fax: +43-1 90 5 60-1333

Belgium – Kessel-Lo
 Phone: +32-16-35-23-00
 Fax: +32-16-35-23-52

Bulgaria – Sofia
 Phone: +359-2-971-2152
 Fax: +359-2-971-2153

Czech Republic – Kurim
 Phone: +420-5-41-162-111
 Fax: +420-5-41-162-223

Denmark – Glostrup
 Phone: +45-43-480-452
 Fax: +45-43-441-414

Egypt – Cairo
 Phone: +20-2-29 04 281
 Fax: +20-2-41 92 334

Estonia – Tartu
 Phone: +372-5138-274
 Fax: +372-7400-779

Finland – Helsinki
 Phone: +358-95-12-34-20
 Fax: +358-95-12-34-250

France – Cergy-Pontoise
 Phone: +33-1-3420-8888
 Fax: +33-1-3420-8600
**Product Information Center:
 (Technical Support)**
 Phone: +33-1-3420-8943
 Fax: +33-1-3420-8623

Germany – Bensheim
 Phone: +49-6251-133-0
 Fax: +49-6251-133-1600
**Product Information Center:
 (Technical Support)**
 Phone: +49-6251-133-1999
 Fax: +49-6251-133-1988

Germany – Langen
 Phone: +49-6103-709-0
 Fax: +49-6103-709-1223

Germany – Speyer
 Phone: +49-6232-30-0
 Fax: +49-6232-30-2243

Germany - HTS Division – Neunkirchen
 Phone: +49-2247-305-0
 Fax: +49-2247-305-122

Greece – Athens
 Phone: +30-210-9370-396/397
 Fax: +30-210-9370-655

Hungary – Budapest
 Phone: +36-1-289-1000
 Fax: +36-1-289-1010

Ireland – Dublin
 Phone: +353-1-820-3000
 Fax: +353-1-820-9790

Israel – Yokneam
 Phone: +972-4-959-0508
 Fax: +972-4-959-0506

Italy – Collegno (Torino)
 Phone: +39-011-4012-111
 Fax: +39-011-4031116

Lithuania – Vilnius
 Phone: +370-5-2131-402
 Fax: +370-5-2131-403

Netherlands – 's-Hertogenbosch
 Phone: +31-73-624-62-46
 Fax: +31-73-621-23-65
**Product Information Center:
 (Technical Support)**
 Phone: +31-73-6246-999
 Fax: +31-73-6246-998

Norway – Nesbru
 Phone: +47-66-77-8886
 Fax: +47-66-77-8855

Poland – Warsaw
 Phone: +48-22-45-76-700
 Fax: +48-22-45-76-720

Romania – Bucharest
 Phone: +40-21-311-3479/3596
 Fax: +40-21-312-0574

Russia – Moscow
 Phone: +7-495-926-5506/07/08/09
 Fax: +7-495-926-5505

Russia – St. Petersburg
 Phone: +7-812-718-8192
 Fax: +7-812-718-8193

Slovenia – Ljubljana
 Phone: +386-1561-3270
 Fax: +386-1561-3240

South Africa – Port Elizabeth
 Phone: +2741-503-4500
 Fax: +2741-581-0440

Spain – Barcelona
 Phone: +34-93-291-0330
 Fax: +34-93-201-7879
**Product Information Center:
 (Technical Support):**
 Phone: +34-93-291-0330
 Fax: +34-93-200-3779

Sweden – Upplands Väsby
 Phone: +46-8-50-72-50-00
 Fax: +46-8-50-72-50-01

Switzerland – Steinach
 Phone: +41-71-447-0447
 Fax: +41-71-447-0444

Turkey – Istanbul
 Phone: +90-212-281-8181/2/3
 Fax: +90-212-281-8184

Ukraine – Kiev
 Phone: +380-044-206-2265
 Fax: +380-044-206-2264

United Kingdom – Swindon
 Phone: +44-8706-080-208
 Fax: +44-1793-572-516
**Product Information Center:
 (Technical Support)**
 Freephone GB: 0800-267-666
 Phone: +44-8706-080-208
 Fax: +44-208-420-8081

**For Middle East/African Countries
 Not Shown**
 Phone: +33-1-3420-8866
 Fax: +33-1-3420-8300

Tyco Electronics Corporation
Harrisburg, PA

tycoelectronics.com

1242132-7.5M-LUG-FP-5-07

