

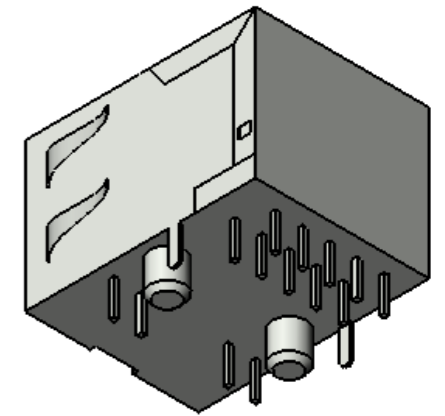

MC

**Recommended Hole Pattern
View From Component Side**

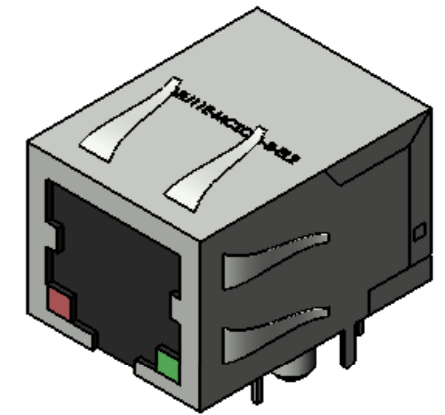
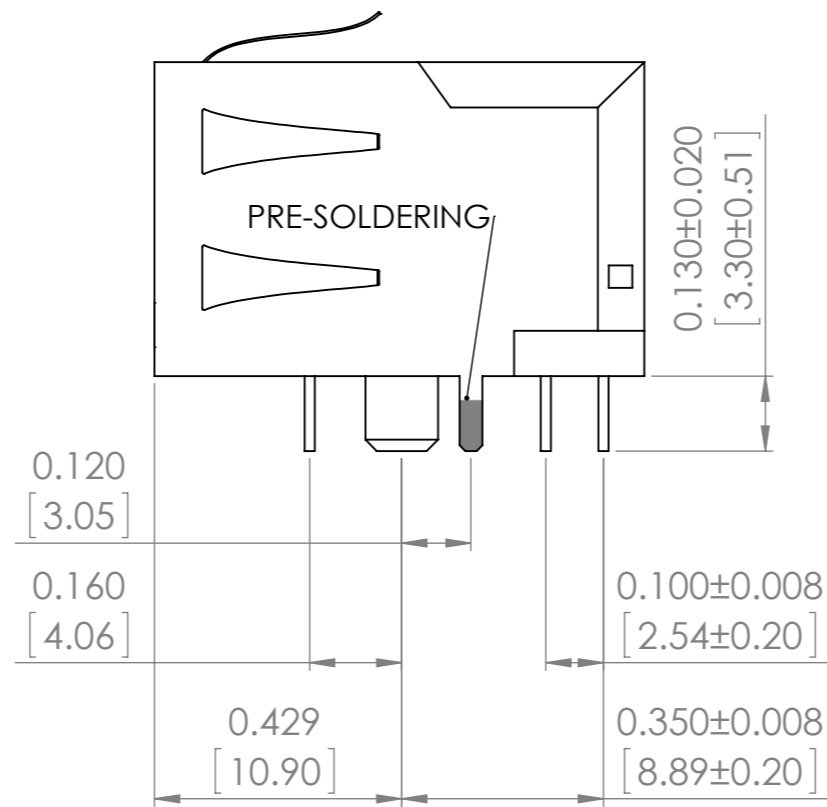
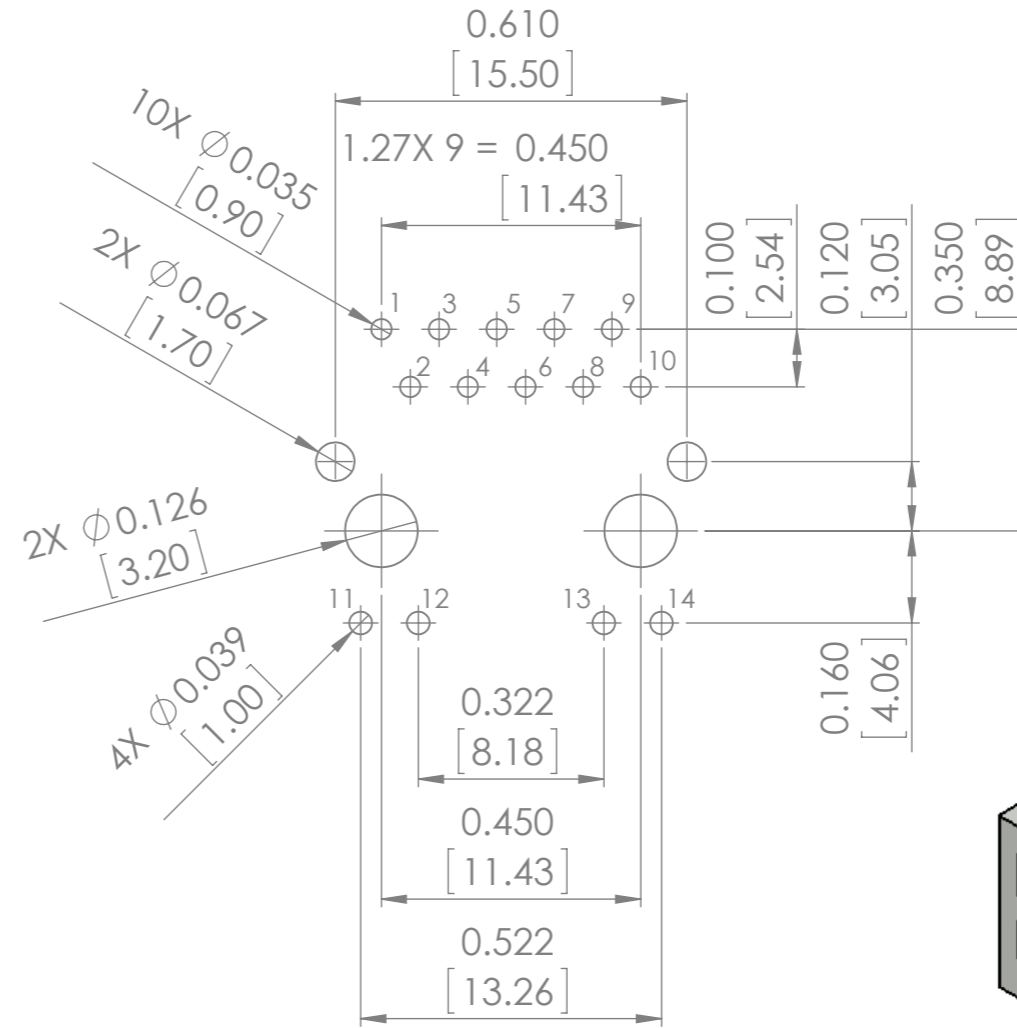
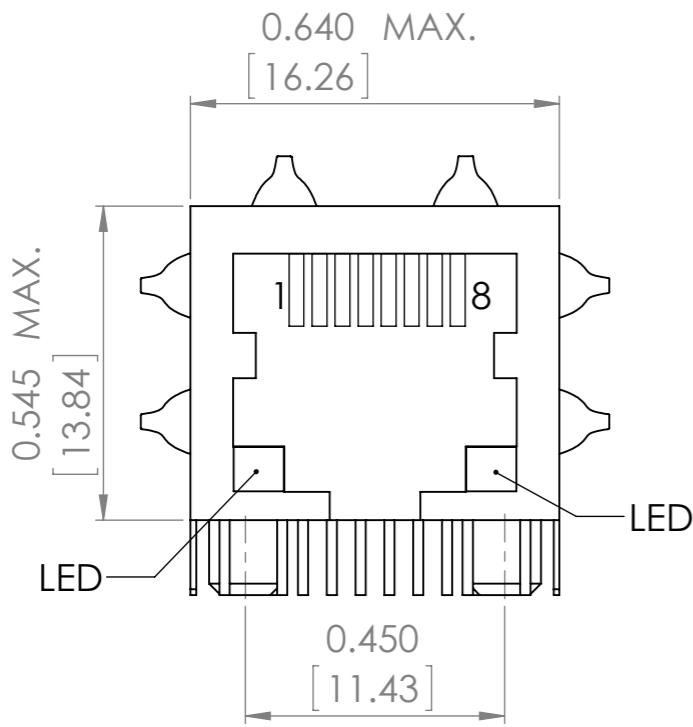
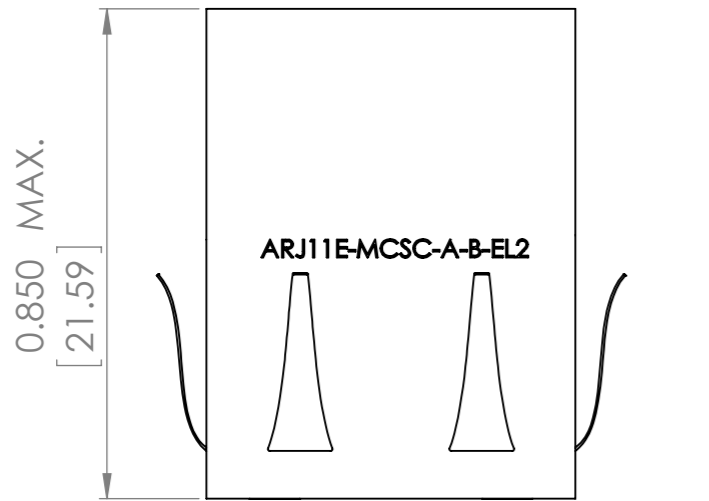

DO NOT SCALE DRAWING		REVISION -	
 ABRACON LLC <small>The Power of Linking Together</small>			
5101 Hidden Creek Lane, Spicewood Texas-78669			
TITLE:		RJ45	
DWG NO.		ARJ11E-MCSC-A-B-EL2	A3
SCALE: 3:1		SHEET 1 OF 1	